



# SBI-521

## Indicator Series



# Service Manual

**© Avery Weigh-Tronix, LLC 2012. All rights reserved.**

No part of this publication may be reproduced, stored in an electronic retrieval system, or transmitted in any form or by any means, electronic, mechanical, photocopying, recording or otherwise without the prior written consent of the copyright owner, or as permitted by law or under license. Full acknowledgment of the source must be given. Avery Weigh-Tronix is a registered trade mark of the Avery Weigh-Tronix, LLC. This publication was correct at the time of going to print however, Avery Weigh-Tronix, LLC reserves the right to alter without notice the specification, design, price or conditions of supply of any product or service at any time.

All third party brands and product names used within this document are trademarks or registered trademarks of their respective holders.

# Table of Contents

<b>Chapter 1 General information and warnings</b> .....	4
About this Manual .....	4
Text Conventions .....	4
Special Messages .....	4
Warnings .....	5
Installation .....	5
Charge the Battery .....	5
Connections .....	6
Weigh Platform or Loadcell Connections .....	7
Serial Port Connections (RS-232) .....	7
RS-485 Connections .....	8
Power Supply Connections .....	9
Routine Maintenance .....	9
Sharp Objects .....	9
Cleaning the Indicator .....	10
<b>Chapter 2 Configuration</b> .....	11
Front Panel .....	11
LED Version .....	11
LCD Version .....	12
Display .....	12
LED .....	12
LCD .....	13
Keyboard .....	14
Navigating the Weigh Mode .....	16
Change the working mode .....	16
Enter or Exit the HOLD Mode .....	16
Zero .....	16
Tare .....	16
Preset Tare Weight .....	16
Clear Tare Weight .....	16
Output Data .....	17
Display Gross or Net Weight .....	17
Change Weight Unit .....	17
Check Weight .....	19
Navigating the Count Mode .....	19
Enter Count Mode .....	20
Obtain Piece Weight .....	20
Check Counts (counts compare) in Counting mode: .....	21
Percent Weigh Mode .....	21
Enter Percent Weighing Mode .....	21
Obtain Percentage Weight .....	22
Check Percent (percentage compare) in Percent Weighing Mode .....	23
Hold Function .....	23
Activate the Hold Function .....	24
Access the Hold Mode .....	24
Hold Methods .....	24
Hold Annunciators .....	25
Data Compare Function .....	26
Enable Data Compare Function .....	26
View Data Compare Function .....	26
Accumulation .....	26
Enable Accumulation .....	27
Display and Set Time .....	28

Display and Set Date .....	28
Display Firmware Version .....	29
Display Interface Type of COM2 .....	29
Display Test .....	29
Keyboard and Buzzer Test .....	30
Serial Port1/2 (COM1/2) Receiving Test .....	30
Serial Port1/2(COM1/2) Transmitting Test .....	30
<b>Chapter 3 Setup Mode .....</b>	<b>32</b>
Entering the Setup Menu .....	32
Navigating the Setup Menu .....	32
Setup Menu Parameters .....	33
Config Menu .....	33
User Menu .....	36
Cal Menu .....	42
Misc Menu .....	43
Test Menu .....	44
Exit the Setup Menu .....	44
<b>Chapter 4 Calibration .....</b>	<b>45</b>
Calibration Mode .....	45
Weight Fine-tune .....	46
Display ADC Output Code .....	47
Display and Calibrate Power Voltage .....	47
<b>Chapter 5 Serial Communication .....</b>	<b>49</b>
Com Port 1 .....	49
Com Port 2 .....	49
Protocol .....	49
Transaction String .....	49
Commands and response .....	50
Single .....	51
Multiple .....	53
<b>Chapter 6 Legal for Trade .....</b>	<b>55</b>
Configuration/Calibration Switch .....	55
Audit Trail Parameters .....	55
View Configuration Counter .....	56
View Calibration Counter .....	56
<b>Chapter 7 Specifications .....</b>	<b>57</b>
SBI-521 Series Models .....	57
Housing and Outline Dimension .....	57
Housing .....	57
Outline Dimension .....	57
Power Supply .....	58
Display .....	58
Keypad .....	58
Environment .....	58
Load Cell Excitation .....	58
Communication .....	59
Analog Circuitry .....	59
Capacity and Division .....	59
Accuracy .....	59
Calibration Method: .....	59
Real Clock .....	59
Other Main Functions .....	60
<b>Chapter 8 Troubleshooting .....</b>	<b>61</b>

Display Characters .....	61
Display Symbols .....	62
Troubleshooting .....	63

# 1 General information and warnings

## 1.1 About this Manual

---

This manual is divided into chapters by the chapter number and the large text at the top of a page. Subsections are labeled as shown by the 1 and 1.1 headings shown above. The names of the chapter and the next subsection level appear at the top of alternating pages of the manual to remind you of where you are in the manual. The manual name and page numbers appear at the bottom of the pages.

### 1.1.1 Text Conventions

---

The keys used to interface with the SBI-521 are located on the front panel of the indicator. The keystrokes are shown in **BOLD** incased between brackets. (e.g. **[ZERO]**)

Displayed messages appear in ***bold italic*** type and reflect the case of the displayed message.

### 1.1.2 Special Messages

---

Examples of special messages you will see in this manual are defined below. The signal words have specific meanings to alert you to additional information or the relative level of hazard.



---

**CAUTION!**

*This is a Caution symbol.*

*Cautions give information about procedures that, if not observed, could result in damage to equipment or corruption to and loss of data.*

---



---

**ELECTRICAL WARNING!**

***THIS IS AN ELECTRICAL WARNING SYMBOL.***

***ELECTRICAL WARNINGS MEAN THAT FAILURE TO FOLLOW SPECIFIC PRACTICES OR PROCEDURES MAY RESULT IN ELECTROCUTION, ARC BURNS, EXPLOSIONS OR OTHER HAZARDS THAT MAY CAUSE INJURY OR DEATH.***

---



---

*NOTE: This is a Note symbol. Notes give additional and important information, hints and tips that help you to use your product.*

---

## 1.2 Warnings

---

- Avoid lengthy exposure to extreme heat or cold. Your scale works best when operated at normal room temperature. Always allow the scale to acclimate to a normal room temperature before use.
- Allow sufficient warm up time. Turn the scale on and wait for a few minutes if possible. This will give the internal components a chance to stabilize before weighing.
- These electronic scales are precision instruments. Do not operate near an in-use cell phone, radio, computer or other electronic device. These devices emit RF and can cause unstable scale readings. If your scale ever performs poorly, try moving the scale to a different room or location.
- Avoid using in heavy vibration and airflow conditions.
- Read the weight reading in short time after loading. The output signature of load cell and electronic circuit may be little influenced after weighing for a long time.

## 1.3 Installation

---



***DANGER: RISK OF ELECTRICAL SHOCK. BE SURE TO UPLUG THE INDICATOR BEFORE REMOVING THE COVER OR OPENING THE UNIT. REFER TO QUALIFIED SERVICE PERSONNEL FOR SERVICE.***

---

1. Unpack the indicator and all components from the shipping box.
2. Remove all back panel screws to expose the indicator main board.
3. Insert the loadcell cable through the loadcell strain relief gland.
4. Connect the loadcell cable to the indicator via the loadcell connector. Refer to section 1.4.1 for connection details.
5. Connect all other cables be used. Refer to the respective sections for connection details.
6. Place back panel on the rear of the indicator and fasten it with the back panel screws.

### 1.3.1 Charge the Battery

---

If you have a Model SBI-521EB or SBI-521CB the battery may need to be charged.

1. Take the indicator to a power outlet located indoors.
2. Attach one end of the charger unit to the underside of the indicator and plug the other end of the charger unit to the power outlet.



---

*It will take approximately 12 hours to fully charge the 6 volt 2.8Ah battery.*

---



**CAUTION:** Danger of explosion if battery is incorrectly replaced. Replace only with the same or equivalent type recommended by the manufacturer. Dispose of used batteries according to the manufacturer's instructions.

**ATTENTION:** Il y a danger d'explosion s'il y a remplacement incorrect de la batterie, remplacer uniquement avec une batterie du même type ou d'un type équivalent recommandé par le constructeur. Mettre au rebut les batteries usagées conformément aux instructions du fabricant.

## 1.4 Connections

Figure 1.1 shows mainboard connectors for the loadcell, printer or computer, power supply and battery. The rear cover of the stainless steel enclosure must first be removed to make the appropriate connections to the weigh platform, printer, remote display and power supply.

To gain access to the connectors, remove the rear panel screws on the back of the indicator.

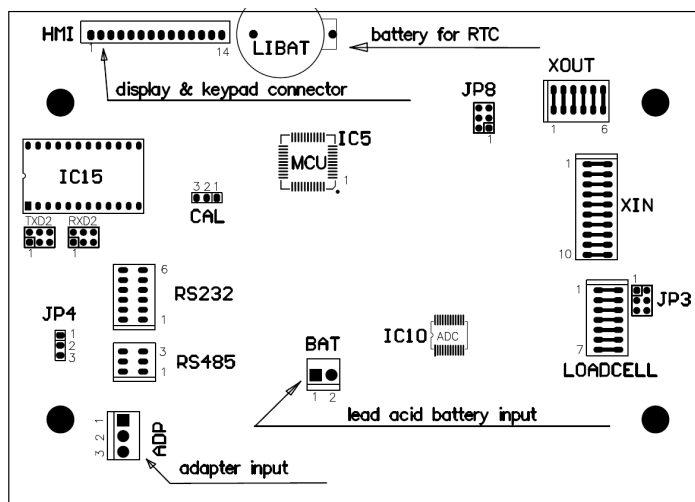

Figure 1.1 SBI-521 Main Circuit Board



## 1.4.1 Weigh Platform or Loadcell Connections

Connect the loadcell cable to the loadcell connector on the main board. Connection assignments for the loadcell connector are shown in [Figure 1.2](#)

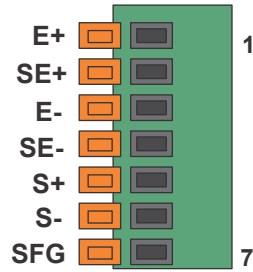

Figure 1.2 Loadcell Connector

Table 1.1 Loadcell Connections

Board Designation	Description	Pin	Electrical Level
E+	+ excitation	1	$5 \pm 0.3$ VDC ( $\leq 0.12$ A)
SE+	+ sense	2	$5 \pm 0.3$ VDC
E-	- excitation	3	$\leq 0.5$ VDC
SE-	- sense	4	0 VDC
S+	+ signal	5	$2.5 \pm 0.3$ VDC
S-	- signal	6	$2.5 \pm 0.3$ VDC
SFG	ground/shield	7	N/A

Set the calibration jumper for desired calibration results.

Table 1.2 Calibration Jumper (JP3)

Connected Pins	Function
1-2	Calibration Enabled
2-3	Calibration Disabled

## 1.4.2 Serial Port Connections (RS-232)

The SBI-521 indicator comes standard with two full Bi-directional RS-232 serial ports designed for connection to either a PC or a serial printer.

Connect the serial printer or computer to the RS-232 terminal on the main board. Communication terminal connections are shown in [Figure 1.3](#).

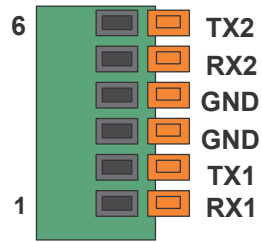

Figure 1.3 RS-232 Connector

Table 1.3 RS-232 Port Connections

Designation	Description	Pin	Electrical Level
RX1	port 1 receive	1	-12 to +12 VDC
TX1	port 1 transmit	2	-12 to +12 VDC
GND	ground/common	3	0 VDC
GND	ground/common	4	0 VDC
RX2	port 2 receive	5	-12 to +12 VDC
TX2	port 2 transmit	6	-12 to +12 VDC

### 1.4.3 RS-485 Connections

The SBI-521 indicator comes standard with one RS-485 network port designed for local networks and multidrop communication links.



Figure 1.4 RS-485 Connection

Designation	Description	Pin	Electrical Level
A	RS-485 signal A	1	0 VDC
B	RS-485 signal B	2	0 - 5 VDC
GND	ground/common	3	0 - 5 VDC

Table 1.4 Termination Resistor Jumper (JP4)

Connected Pins	Function
1-2	RS485 terminal 120ohm resistor on board is disabled
2-3	RS485 terminal 120ohm resistor on board is enabled

## 1.4.4 Power Supply Connections

---

The SBI-521 comes standard with an external AC to DC power adapter. Simply plug the AC adapter into the indicator DC power jack and then plug into a standard wall outlet.



---

**IMPORTANT:** Make sure that the AC voltage appearing at the wall outlet matches the input voltage marked on the AC adapter.

---

**Table 1.5 Adapter Power Input Connector (ADP)**

Pin	Definition	In/Out/Power	Electrical Level
1	Adapter input voltage +	Power input	12VDC (10.5-15VDC, $\geq 0.5A$ )
2	Adapter input voltage - (GND)	Power ground	0Vdc
3	Shell Earth	N/A	N/A

**Table 1.6 Battery Power Input Connector (BAT)**

Pin	Definition	In/Out/Power	Electrical Level
1	Battery input voltage +	Power input	5.6-7.2Vdc (6V/2.8AH lead acid battery)
2	Battery input voltage -(GND)	Power ground	0Vdc

## 1.5 Routine Maintenance

---



---

**IMPORTANT:** This equipment must be routinely checked for proper operation and calibration. Application and usage will determine the frequency of calibration required for safe operation.

---

Always turn off the machine and isolate from the power supply before starting any routine maintenance to avoid the possibility of electric shock.

## 1.6 Sharp Objects

---

Do not use sharp objects such as screwdrivers or long fingernails to operate the keys.

## 1.7 Cleaning the Indicator

---

Table 1.7 Cleaning DOs and DON'Ts



DO	DO NOT
Wipe down the outside of standard products with a clean cloth, moistened with water and a small amount of mild detergent	Attempt to clean the inside of the indicator
	Use harsh abrasives, solvents, scouring cleaners or alkaline cleaning solutions
Spray the cloth when using a proprietary cleaning fluid	Spray any liquid directly on to the display window

## 2 Configuration

To set up the indicator, you must first enter the appropriate menu mode. The front panel keys become directional navigators to move around in the menus. See [Table 2.3](#) for details.

### 2.1 Front Panel

---

The front panel incorporates the display and keypad.

#### 2.1.1 LED Version

---

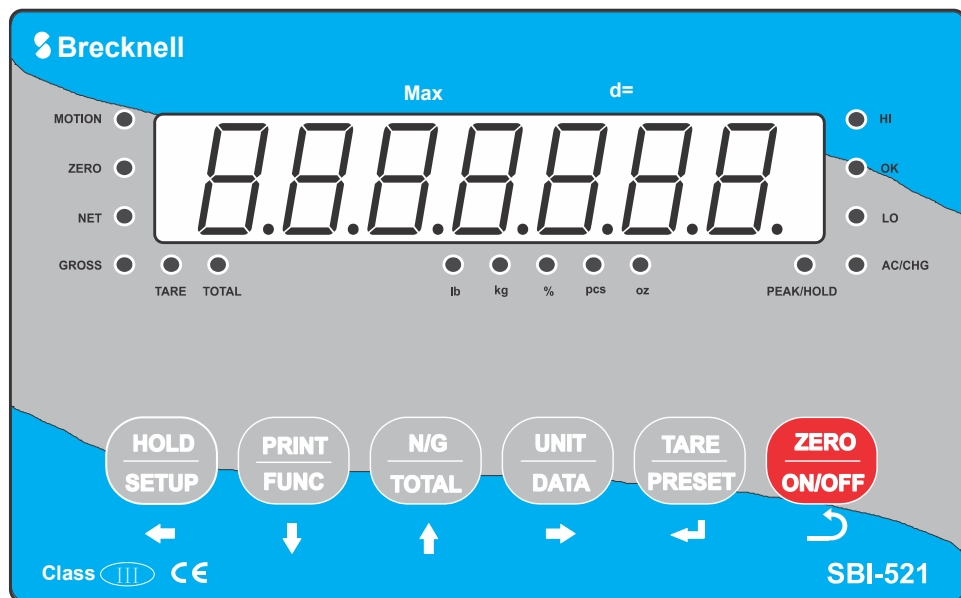

## 2.1.2 LCD Version

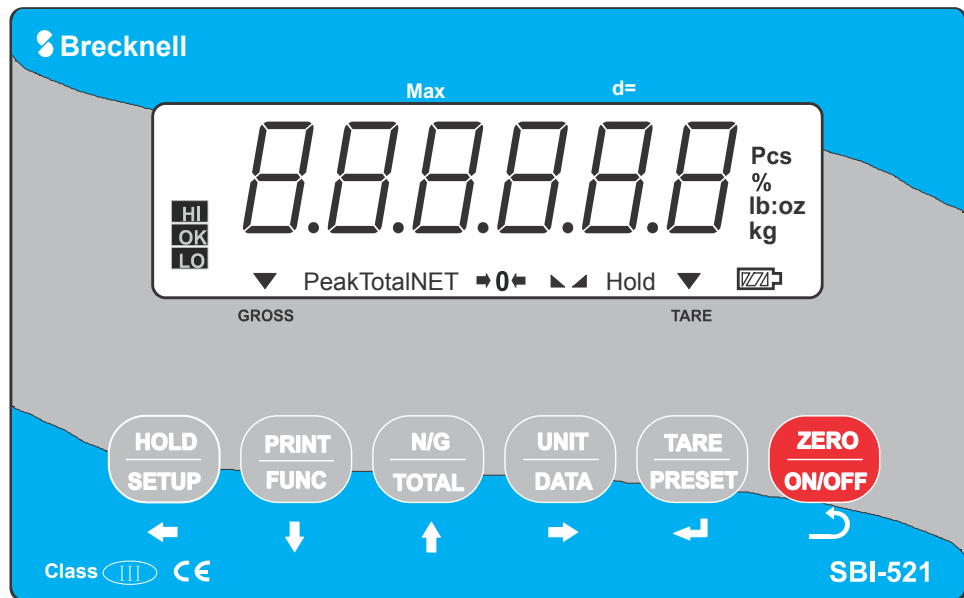

## 2.2 Display

The Model SBI-521 indicator utilizes a 6-digit LCD (Liquid Crystal Display) or a 7-digit LED display providing the weight and system information.

### 2.2.1 LED

The annunciators used with the LED model surround the display. The annunciator will be lit when the mode is active.

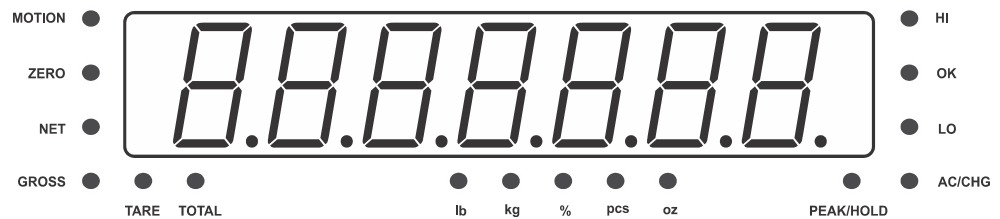

Figure 2.1 LED Display

**Table 2.1 LED Display Annunciators and Definitions**

LED Annunciator	Description
<b>ZERO</b>	Better known as the "Center of Zero" annunciator. It is lit whenever the displayed weight is within $\pm 0.25$ divisions of true zero.
<b>MOTION</b>	Illuminates when weight is within motion band.
<b>PEAK/HOLD</b>	(1) flashing/not flashing: working HOLD mode and displaying number is/isn't live (2) red/green: working in HOLD mode and HOLD type is/isn't PEAK-HOLD
<b>TOTAL</b>	Display data is total times or total of weight, pieces or percentage.
<b>NET</b>	Indicates current weight is in the net mode and the tare weight is not 0.
<b>GROSS</b>	Indicates current weight is in the gross mode.
<b>TARE</b>	Indicates current weight is in the tare mode.
<b>Pcs</b>	indicates counting mode
<b>AC/CHG</b>	Illuminates red when battery is being charged or green if battery is fully charged or not installed.
<b>lb</b>	Indicates the current unit of measure is lb.
<b>oz</b>	Indicates the current unit of measure is oz.
<b>kg</b>	Indicates the current unit of measure is kg.
<b>%</b>	Indicates the current unit of measure is in percentage weighing mode.
<b>HI</b>	Illuminates when data compare is enabled and current data (weight, pieces or percent) is over the specified upper limit.
<b>OK</b>	Illuminates when data compare is enabled and current data (weight, pieces or percent) is between the specified upper and lower limits.
<b>LO</b>	Illuminates when data compare is enabled and current data (weight, pieces or percent) is over the specified lower limit.

### **2.2.2 LCD**

The annunciators used with the LCD model are incorporated in the display. The annunciator will be lit when the mode is active.

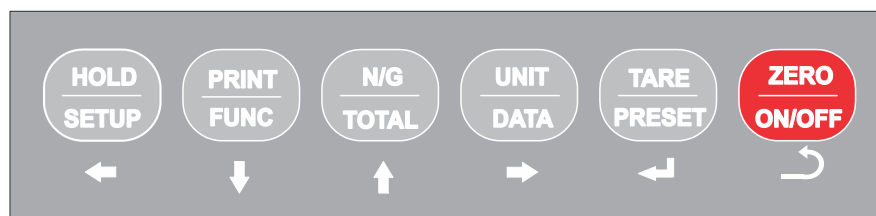

**Table 2.2 LCD Display Annunciators and Definitions**

LCD Annunciator	Description
⇒ 0 ⇐	Better known as the "Center of Zero" annunciator. It is lit whenever the displayed weight is within $\pm 0.25$ divisions of true zero.
▲ ▼	Illuminates when weight is within motion band.
Hold	Flashes when hold key is pressed. Remains permanently on when the Hold function has become activated.
Peak	
Total	Display data is total times or total of weight, pieces or percentage.
NET	Indicates net mode and the tare weight is not 0.
GROSS	Indicates gross mode when arrow above GROSS is illuminated.
TARE	Indicates tare mode when arrow above TARE is illuminated.
Pcs	indicates counting mode
	When battery is being used or charged..
lb	Indicates the current unit of measure is lb.
oz	Indicates the current unit of measure is oz.
kg	Indicates the current unit of measure is kg.
%	Indicates the current unit of measure is in percentage weighing mode.
HI	Illuminates when data compare is enabled and current data (weight, pieces or percent) is over the specified upper limit.
OK	Illuminates when data compare is enabled and current data (weight, pieces or percent) is between the specified upper and lower limits.
LO	Illuminates when data compare is enabled and current data (weight, pieces or percent) is over the specified lower limit.

## 2.3 Keyboard













The keyboard consists of six keys, some of which have multiple functions.



**Figure 2.2 SBI-521 Keypad**



**Table 2.3 Function of the Keys**

Key	Mode	Condition	Function
 	Weigh, count or percent	Press for less than 3 seconds	Enter or exit HOLD mode
	Weigh, count or percent	Press for more than 3 seconds	Enter setup mode
	Input data	Press for more than 3 seconds	Input decimal point
	Input data	Press for less than 3 seconds	Return to sub menu
	Setup	Press for more than 3 seconds	Exit setup. Refer to page 44
 	Weigh, count or percent	Press for less than 3 seconds	Output data to serial communication port
	Weigh, count or percent	Press for more than 3 seconds	Select working mode (weigh, count or percent)
	Input data	Press to enter data	one will be subtracted from the flashing digit.
	Setup	Menu selection mode	Next item of current menu
 	Weigh, count or percent	Press for less than 3 seconds	To display net weight or gross weight mode
	Weigh, count or percent	Press for more than 3 seconds	To add up current weight/pieces/percentage to memory, display times and total of accumulation
	Input data	Press to enter data	one will be added to the flashing digit.
	Setup	Menu selection mode	To last item of current menu
 	Weigh	Press for less than 3 seconds	Change weigh units
	Count or percent	Press for less than 3 seconds	To enter a piece weight or unit percentage weight (by way of sample or input directly)
	Weigh, count or percent	Press for more than 3 seconds	To input compare data (for weight, pieces or percentage) of high and low limitation
	Setup	Input data mode	Rotate the flashed position from left to right
 	Weigh, count or percent	Press for less than 3 seconds	Tare function
	Weigh, count or percent	Press for more than 3 seconds	Input preset tare weight
	Input data or setup	Input data or select menu	Confirm input data or current item selection and go to next item of current menu or next operation
 		Indicator is off	Power on
	Weigh, count or percent	Press for less than 3 seconds	Zero function
	Weigh, count or percent	Press for more than 3 seconds	Power off
	Setup	Input data mode	ignore modification
	Setup	Menu selection mode	Prepare to exit from current working mode

## 2.4 Navigating the Weigh Mode

---

### 2.4.1 Change the working mode

---

Press the **[FUNC]** key for 3 seconds. Use the **[FUNC]** key to choose and confirm entry into weighing mode, counting mode or percentage working mode. The count and/or percentage mode must be set to yes in the FUNC menu within the setup mode. Otherwise the indicator will only show the weighing mode. Refer to page [33](#) for details.

### 2.4.2 Enter or Exit the HOLD Mode

---

Press the **[HOLD]** key.

### 2.4.3 Zero

---

When the weight is stable and within the zero range, press the **[ZERO]** key to set a new zero point. Refer to [Table 2.4](#) for zero limitations.

### 2.4.4 Tare

---

When the gross weight is larger than zero and the scale is stable, press the **[TARE]** key. The indicator will show a net weight of zero and the NET annunciator will be illuminated. Refer to [Table 2.4](#) for tare limitations.

### 2.4.5 Preset Tare Weight

---

Enter a preset tare weight by pressing the **[PRESET]** key for more than 3 seconds. **Pr.Tare** will be displayed and the TARE annunciator flashes. Use the up and down arrow keys to input the desired tare weight and the right arrow key to move to the next digit. The value entered must be larger than zero and there is no limitation to preset tare weight. After the tare weight is entered the NET annunciator will illuminate. Refer to [Table 2.4](#) for tare limitations.

Note: This indicator can only save one tare weight. The new tare weight will automatically replace the old one.

### 2.4.6 Clear Tare Weight

---

Remove any weight on platform and wait until the scale is stable. Press the **[TARE]** key.

**Table 2.4 Zero and Tare Limitations**

Standard	Weight on platform	Data in TARE memory unit	key function	
			Tare key	Zero key
USA	≤0	no	No action	Zero
		yes	Clear the tared weight	
	>0	no	Tare	
		yes		
Canada	≤0	no	No action	Zero
		yes	Clear the tared weight	
	>0	no	Tare	
		yes	No action	
Europe	≤0	no	No action	Zero
		yes	Clear the tared weight	zero and clear the tared weight
	>0	no	Tare	zero
		yes		zero and clear the tared weight
None (same with Europe)	≤0	no	No action	Zero
		yes	Clear the tared weight	zero and clear the tared weight
	>0	no	Tare	zero
		yes		zero and clear the tared weight

### **2.4.7 Output Data**

When scale is stable press the **[PRINT]** key.

### **2.4.8 Display Gross or Net Weight**

If the tare weight is not zero, press the **[N/G]** key to display NET weight or GROSS weight.

If the tare weight is zero, GROSS weight will be displayed.

### **2.4.9 Change Weight Unit**

Press the **[UNIT]** key to select kg, lb or lb:oz. Note: under some conditions lb:oz is not available. Please refer the following table.

**Table 2.5 Use kg as Primary Unit**

Calibration Division Value	Display Division Value		
	kg	lb	lb:oz
0.0001kg	0.0001kg	0.0002lb	Not available
0.001kg	0.001kg	0.002lb	Not available
0.01kg	0.01kg	0.02lb	0.5oz
0.1kg	0.1kg	0.2lb	Not available
1kg	1kg	2lb	Not available
10kg	10kg	20 lb	Not available
0.0002kg	0.0002kg	0.0005 lb	Not available
0.002kg	0.002kg	0.005 lb	0.1 oz
0.02kg	0.02kg	0.05 lb	1 oz
0.2kg	0.2kg	0.5 lb	Not available
2kg	2kg	5 lb	Not available
20kg	20kg	50 lb	Not available
0.0005kg	0.0005kg	0.001 lb	Not available
0.005kg	0.005kg	0.01 lb	0.2 oz
0.05kg	0.05kg	0.1 lb	2oz
0.5kg	0.5kg	1 lb	Not available
5kg	5kg	10 lb	Not available
50kg	50kg	Not available	Not available

**Table 2.6 Use lb as Primary Unit**

Calibration Division Value	Display Division Value		
	kg	lb	lb:oz
0.0001lb	Not available	0.0001lb	Not available
0.001 lb	0.0005 kg	0.001 lb	Not available
0.01 lb	0.005 kg	0.01 lb	0.2 oz
0.1 lb	0.05 kg	0.1 lb	2 oz
1 lb	0.5 kg	1 lb	Not available
10 lb	5 kg	10 lb	Not available
0.0002 lb	0.0001 kg	0.0002 lb	Not available
0.002 lb	0.001 kg	0.002 lb	Not available
0.02 lb	0.01 kg	0.02 lb	0.5 oz
0.2 lb	0.1 kg	0.2 lb	Not available
2 lb	1 kg	2 lb	Not available
20 lb	10 kg	20 lb	Not available
0.0005 lb	0.0002 kg	0.0005 lb	Not available

Calibration Division Value	Display Division Value		
	kg	lb	lb:oz
0.005 lb	0.002 kg	0.005 lb	0.1 oz
0.05 lb	0.02 kg	0.05 lb	1 oz
0.5 lb	0.2 kg	0.5 lb	Not available
5 lb	2 kg	5 lb	Not available
50 lb	20 kg	50 lb	Not available

## 2.4.10 Check Weight

To make the weight compare function be available, CONFIG-FUNC-COMPAR item should set to YES. The high and low limitation of weight should be set correctly according to following steps:

1. In weighing mode, press the **[DATA]** key more than 3 seconds.
2. The unit setting will be shown (Unit.kg, Unit.lb). Use the **[UNIT]** key to change the unit or the **[TARE]** key to continue.
3. After the HIGH parameter is accessed, 000000 will be displayed. Use the **[PRINT]**, **[N/G]** and **[UNIT]** keys to input the high weight value.
4. Press the **[TARE]** key to confirm the entry. The HI annunciator will be on.
5. Press the **[ZERO]** key to go to the low value.
6. After Low is accessed, 000000 will be displayed. Use the **[PRINT]**, **[N/G]** and **[UNIT]** keys to input low weight number.
7. Press the **[TARE]** key to confirm. The LO annunciator will be displayed.
- 7a. After a reasonable limitation is set and compare is active, one of annunciators HI, OK, LO will be illuminated. The beeper will sound according to its setting in USER-BEEP.



---

*NOTE: If the High number value is 0 or is equal or less than low number, the comparison will be disabled, and the input data has no limitation.*

---

## 2.5 Navigating the Count Mode

1. In this mode, scale will weigh goods weight on scale, calculate and display its counts after the piece weight of goods is obtained. The count function must be enabled in the setup mode. The CONFIG-FUNC-COUNT item should be set to YES in CONFIG menu.

## **2.5.1 Enter Count Mode**

1. To enter counting mode press the **[FUNC]** key for more than 3 seconds. WEIGH will be displayed.
2. Use the **[N/G]** or **[PRINT]** key to select COUNT.
3. Press **[TARE]** to confirm the parts counting mode. The pcs annunciator will be illuminated.
- 3a. In counting mode, the function of **[ZERO]**, **[TARE]**, **[PRINT]**, **[HOLD]**, **[TARE]**, **[N/G]**, **[SETUP]**, **[ON/OFF]** keys are available.

## **2.5.2 Obtain Piece Weight**

There are two ways to obtain the piece weight:

### **Input piece weight directly**

1. Press the **[UNIT]** key.
2. When InP.PWt is displayed, press the **[TARE]** key to enter into the piece weight mode.
3. When UNIT.KG is shown, use the **[PRINT]** or **[N/G]** key to select the unit of piece weight.
4. Use the **[TARE]** key to confirm and go to piece weigh entry.
5. Press the **[ZERO]** key to exit the piece weight mode and back to counting mode.
6. When last stored piece weight is shown, use **[PRINT]**, **[N/G]**, **[UNIT]** key to input new piece weight.
7. Press the **[SETUP]** key more than 3 seconds to input decimal point.
8. Press the **[TARE]** key to confirm the entry and save it.
- 8a. If the input piece weight is less than 0.5d, the indicator will display PWt.Er and go back to counting mode.

### **Sample a Known Quantity**

1. Place sample pieces on the scale.
1. Press the **[UNIT]** key.
2. When InP.PWt is shown, use the **[PRINT]** or **[N/G]** key to select SPL.PWT.
3. Press the **[TARE]** key to weigh samples (which quantity is known) weight, calculate piece weight.
4. When SPL.Lo is shown, remove the sample on scale and press the **[TARE]** key to confirm.
5. When SPL.Hi is shown, put samples (its quantity is known) onto the scale, Press the **[TARE]** key to confirm reading weight.
6. After INP.PCS is displayed, 000000 will be shown. Use the **[PRINT]**, **[N/G]**, **[UNIT]** key to input the quantity of samples.

7. Press the **[TARE]** key to confirm.
- 7a. If the calculated piece weight is less than 0.5d, the indicator will display PWt.Er and go back to counting mode. Otherwise, after the reasonable piece weight has been captured, the scale will go back to counting mode. The piece weight will be saved and used again.

### **2.5.3 Check Counts (counts compare) in Counting mode:**

---

To make counts compare function be available, CONFIG-FUNC-COMPAR item should set to YES, and high and low limitation of pieces should be set correctly according to following steps:

1. In counting mode, press down the **[DATA]** key more than 3 seconds to enter the high and low compare data.
2. When in HIGH mode, 000000 will be displayed. Use the **[PRINT]**, **[N/G]**, **[UNIT]** key to input high quantity number.
3. Press the **[TARE]** key to confirm the entry. The Hi annunciator will be shown on the display.
4. When in LOW mode, 000000 will be displayed. Use the **[PRINT]**, **[N/G]**, **[UNIT]** key to input the low quantity number.
5. Press the **[TARE]** key to confirm the entry. The Lo annunciator will be shown on the display.



---

*NOTE: If the High number value is 0 or is equal or less than low number, the comparison will be disabled.*

---

- 5a. After a reasonable limitation is set and compare is active, one of annunciators HI, OK, LO will be lit and the beeper will sound according to its setting in USER-BEEP.

## **2.6 Percent Weigh Mode**

---

In this mode the scale will calculate the weight on the scale and display its percentage after the unit-percentage-weight is obtained. NOTE: If 100% display format is set to 100%, 100.0% or 100.00% in CONFIG-FUNC-PERCEN menu item, then, the unit-percentage-weight is the weight of 1%, 0.1% or 0.01%.

To make percent weighing function be available, CONFIG-FUNC-PERCEN menu item shouldn't be set to NONE.

### **2.6.1 Enter Percent Weighing Mode**

---

1. From the percent weighing mode, normal weighing or counting mode, press the **[FUNC]** key for more than 3 seconds. WEIGH/COUNT will be shown.
2. Use the **[PRINT]** or **[N/G]** key to select PERCEN.

3. Press the **[TARE]** key to confirm and go to percent weighing mode. The last unit-percentage-weight will be used.
- 3a. In percent weigh mode, the function of **[ZERO]**, **[TARE]**, **[PRINT]**, **[HOLD]**, **[TARE]**, **[N/G]**, **[SETUP]**, **[ON/OFF]** keys are available.

## **2.6.2 Obtain Percentage Weight**

---

There are two ways to obtain the unit percent weight.

### **Input Weight and Percentage**

The scale calculates the unit-percentage weight, refer operations of step 7.5.1 (2) weigh samples weight which percentage is known, refer operation of step 7.5.2. Input weight and its percentage from keypad, and calculate unit-percentage-weight: in percent weighing mode.

1. Press the **[UNIT]** key.
2. When InP.Pct is shown, press the **[TARE]** key to enter this mode.
3. Before entering the weight, use the **[PRINT]** or **[N/G]** key to select the percentage from 1%, 2%, 5%, 10%, 20%, 50% and 100%. This percentage is corresponding to the weight you will input in following steps
4. When UNIT.KG is shown, use the **[PRINT]** or **[N/G]** key to select the unit of input weight.
5. Use the **[TARE]** key to confirm and go to next.
6. When last stored unit-percentage-weight data is shown, use the **[PRINT]**, **[N/G]**, **[UNIT]** keys to input new unit-percentage-weight.
7. Press the **[HOLD]** key more than 3 seconds to input decimal point.
8. Press the **[TARE]** key to confirm and save it.
9. Go back to percent weighing mode. If the calculated unit-percentage-weight is less than 0.5d, the indicator will display Pct.Er and go back to percent weighing mode.

### **Obtain Unit Percentage Weight**

By weighing samples weight which percentage is known.

1. In percent weighing mode, press the **[UNIT]** key,
2. When InP.Pct is shown, use the **[PRINT]** or **[N/G]** key to select SPL.Pct.
3. Press the **[TARE]** key to weigh samples (which percentage is known) weight and calculate piece weight.
4. When SPL.Lo is shown, remove the sample on the scale and press the **[TARE]** key to confirm.
- 4a. Before the scale is stable, SPL.Lo will be flashed. After stability is reached, it will go to next step.
5. When SPL.Hi is shown, place samples (its percentage is known) onto the scale.



6. Press the **[TARE]** key to confirm reading weight.
- 6a. Before scale is stable, SPL.Hi will be flashed. After it is stability is reached, it will go to next step.
7. After INP.PCT is shown, 000000 (position of decimal point is determined by CONFIG-FUNC-PERCEN setting) will be displayed
8. Use the **[PRINT]**, **[N/G]**, **[UNIT]** keys to input the percentage of samples.
9. Press the **[TARE]** key to confirm.
- 9a. If the calculated unit-percentage-weight is less than 0.5d, the indicator will display Pct.Er and go back to percent weighing mode. Otherwise, the scale will go back to percent weighing mode. The unit percentage weight can be saved after the power off and can be used next time.

### **2.6.3 Check Percent (percentage compare) in Percent Weighing Mode**

---

To make percentage compare function be available, CONFIG-FUNC-COMPAR menu item should set to YES, and high and low limitation of percentage should be set correctly according to following steps:

1. In percent weighing mode, Press the **[DATA]** key for more than 3 seconds to enter compare data of high and low.
2. After HIGH is shown, 000000 will be displayed. Use the **[PRINT]**, **[N/G]**, **[UNIT]** keys to input high percentage number.
3. Press the **[TARE]** key to confirm. The HI annunciator will be illuminated.
4. After Low is shown, 000000 will be displayed. use the **[PRINT]**, **[N/G]**, **[UNIT]** keys to input the low percentage number.
5. Press the **[TARE]** key to confirm. The LO annunciator will be illuminated.



---

*NOTE: If the High number value is 0 or is equal or less than low number, the comparison will be disabled.*

---

- 5a. After a reasonable limitation is set and compare is active, one of annunciators HI, OK, LO will be lit and the beeper will sound according to its setting in USER-BEEP.

## **2.7 Hold Function**

---

HOLD function can be used to freeze a displayed number. In this mode, the scale can capture a dynamic number, hold a stable number, or average a unstable number and then HOLD (freeze) this number temporarily for the user to view or record.

The HOLD function can be used in normal weighing mode, counting mode and percent weighing mode. After entering HOLD mode, the speed of A/D converter can be increased to 80Hz (if USER-HOLD-AD.H.SPD is set to YES) from original 10Hz for some dynamic weighing applications.

It is possible to weigh restless weighing samples such as live animals or moving objects within the hold function. The indicator provides special mode settings to accommodate weight movements.

### **2.7.1 Activate the Hold Function**

The CONFIG-FUNC-HOLD menu item must be set to YES.

Menu items of USER-HOLD-HLD.MOD /-AVG.TIM /-HLD.TIM /-DYN.RNG /-STB.TIM, USER-OTHER-NLD.RNG need be set to reasonable value.

To speedup sampling of weight, set USER-HOLD-AD.H.SPD menu item to YES.

### **2.7.2 Access the Hold Mode**

To enter the HOLD mode, press the **[HOLD]** key while in the normal weighing mode, counting mode or percent weighing mode.

### **2.7.3 Hold Methods**

- Positive Peak Number HOLD mode
- Negative Peak Number HOLD mode
- Toggle HOLD mode
- Average HOLD mode
- Auto HOLD mode

The following are details of these HOLD modes:

#### **Positive Peak HOLD**

When USER-HOLD-HLD.MOD is set to PS.PEAK, the hold mode is positive peak hold mode.

When scale first enters this working mode, it will display the largest positive number that is from the time of zero-point set. After entering this working mode, scale will always catches and refresh positive larger number and display it.

To exit HOLD mode, press the **[HOLD]** key again.

#### **Negative Peak HOLD**

When USER-HOLD-HLD.MOD is set to NG.PEAK, the hold mode is negative peak hold mode.

When scale first enters this working mode, it will display the largest negative number from the time of zero-point set. After entering this working mode, scale will always catches negative larger number and display it.

To exit HOLD mode, press the **[HOLD]** key again.

#### **Toggle HOLD**

When USER-HOLD-HLD.MOD is set to TOGGLE, the hold mode is toggled between HOLD and MANUAL HOLD function.

After entering this working mode, the scale will freeze and display number if scale is stable. Only the weight that is over USER-OTHER-NLD.RNG (zero 'dead' band ) can be held.

To exit HOLD mode, press the **[HOLD]** key again. If the time of scale being unstable is more than USER-HOLD-STB, TIM, STB.ER will be shown. Press the **[TARE]** key to start averaging again or press the **[HOLD]** key to exit.

### **Average HOLD**

Set the USER-HOLD-HLD.MOD parameter to AVERAG.

After entering this working mode the scale will freeze and display number if scale is stable. If scale is not stable, but the variation is less than USER-HOLD-DYN.RNG setting, the scale will average data in USER-HOLD-AVG.TIM, then freeze and display the number. Only the weight that is over USER-OTHER-NLD.RNG can be frozen.

The scale will exit HOLD mode according to the setting of USER-HOLD-HLD.TIM. If the time of scale variation being over USER-OTHER-NLD.RNG is more than USER-HOLD-STB.TIM, STB.ER will be shown.

Press **[PRINT]**, **[N/G]**, **[UNIT]** or **[TARE]** to start averaging again, or press the **[HOLD]** key to exit.

### **Auto HOLD**

Set the USER-HOLD-HLD.MOD parameter to AUTO. Different items can be weighed one after another without pressing any buttons.

After entering this working mode, scale will freeze and display number if scale is stable. If scale is not stable, but the variation is less than USER-HOLD-DYN.RNG the scale will average data in USER-HOLD-AVG.TIM, then freeze and display the number. Only the weight that is over USER-OTHER-NLD.RNG can be frozen. If the held weight is moved away and a new load is put on the scale, the new load will automatically be held.

The scale will exit HOLD mode according to the setting of USER-HOLD-HLD.TIM. If the time of scale variation being over USER-OTHER-NLD.RNG is more than USER-HOLD-STB.TIM, STB.ER will be shown. Press the **[TARE]** key to start averaging again or press the **[HOLD]** key to exit.

## **2.7.4 Hold Annunciators**

In Positive or Negative Peak HOLD mode, the red HOLD (for LED version) or PEAK and HOLD (for LCD version) annunciator will be illuminated.

In other HOLD modes the green HOLD (for LED version) or HOLD (for LCD version) annunciator will be illuminated.

When the HOLD annunciator is flashing, the displayed number is live. When HOLD annunciator is steady, the displayed number is frozen.

## 2.8 Data Compare Function

---

Data compare function can be used in normal weighing mode, counting mode and percent weighing mode. It can be called Check Weigher, Check Counts and Check Percentage. When this function is enabled, you can set a higher and a lower limitation of weight, counts or percentage independently. These limitations can be saved permanently. Then, the current data of weight, counts or percentage will be compared with the setting limitation and corresponding annunciator will be illuminated.

### 2.8.1 Enable Data Compare Function

---

To make data compare function be available, CONFIG-FUNC-COMPAR menu item should set to YES, and high and low limitation should be set correctly according to following steps:

### 2.8.2 View Data Compare Function

---

1. From the weighing, counting or percent weighing mode, press the **[DATA]** key more than 3 seconds to enter input compare data of high and low mode.
2. After HIGH is shown, the last saved high value will be displayed. Use the **[PRINT]**, **[N/G]**, **[UNIT]** keys to enter a new high value.
3. Press the **[TARE]** key to confirm. The HI annunciator will be illuminated.
4. After Low is shown, the last saved low value will be displayed. Use the **[PRINT]**, **[N/G]**, **[UNIT]** keys to enter a new low value.
5. Press the **[TARE]** key to confirm. The LO annunciator will be illuminated.
6. Press the **[ZERO]** key to exit and back to original working mode.

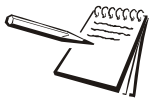

---

*NOTE: If the High number value is 0 or is equal or less than low number, the comparison will be disabled.*

---

After a reasonable limitation is set and compare function is active, one of annunciators HI, OK, LO will be illuminated and the beeper will sound according to its setting in USER-BEEP.

For details refer to *User Menu on page 36*.

## 2.9 Accumulation

---

The accumulation function can be used in weighing, counting and percent weighing mode. When this function is enabled, you can accumulate the current net weight, piece weigh and percentage.



---

*NOTE: When the HOLD function is enabled and the scale is working in PEAK HOLD mode, the accumulation function will be automatically disabled..*

---



---

*NOTE: The positive displayed number can only be totalled when the load on the scale is larger than the USER-OTHER-NLD.RNG value. The number of accumulations and total can be displayed or printed.*

---

## **2.9.1 Enable Accumulation**

To make the accumulation function be available the CONFIG-FUNC-ACCUMU parameter should be set to MANUAL or AUTO.

### **Manual Accumulation**

When CONFIG-FUNC-ACCUMU is set to MANUAL, the stable and positive displayed net weight must be larger than the USER-OTHER-NLD.RNG setting.

Piece or percentage can be accumulated by a long press of the **[TOTAL]** key. The indicator will display accumulation times first and then display total of number.



---

*NOTE: Be sure to remove the accumulated load to avoid duplicating an accumulation. The weight on the scale must be smaller than the setting at USER-OTHER-NLD.RNG to continue.*

---

### **Auto Accumulation**

When CONFIG-FUNC-ACCUMU is set to AUTO, the stable and positive displayed net weight must be larger than the USER-OTHER-NLD.RNG setting.

Piece or percentage can be accumulated automatically. The indicator will display accumulation times first and then display total number of accumulations.



---

*NOTE: Be sure to remove the accumulated load to avoid duplicating an accumulation. The weight on the scale must be smaller than the setting at USER-OTHER-NLD.RNG to continue.*

---

### **View Total**

When the displayed number is zero, press the **[TOTAL]** key for 3 seconds. The indicator will display accumulation times first and then display total of number.

NOTE:

- ZERO only be active when scale is stable and weight is in SAZSM setting range.
- TARE only be active when the scale is stable.

- When the TARE weight or ZERO weight is cleared, the indicator will display the GROSS mode.
- NET weight is displayed when a TARE weight is entered.

## 2.10 Display and Set Time

---

1. Enter the Setup Mode by pressing the **[SETUP]** key more than 3 seconds.
2. Use the **[PRINT]** or **[N/G]** key to select the MISC menu.
3. Press **[TARE]** to select the MISC menu.
4. Press the **[PRINT]** key to scroll to the TIME parameter.
5. Press **[TARE]** to display current time.
- 5a. Time display Format is: txx.xx.xx(hh-mm-ss) for LED Version, 24h format xx:xx:xx(hh-mm-ss) for LCD Version, 24h format.
6. Press the **[DATA]** key for 3 seconds. The first digit of the time will flash.
7. Use the **[PRINT]** or **[N/G]** key to enter the first digit.
- 7a. If time of no operation is more than 5s, it will automatically exit modification mode.
8. Use the **[DATA]** key to move to the next digit.
9. Press the **[SETUP]** key to exit the time entry mode.

## 2.11 Display and Set Date

---

1. Enter the Setup Mode by pressing the **[SETUP]** key more than 3 seconds.
2. Use the **[PRINT]** or **[N/G]** key to select the MISC menu.
3. Press **[TARE]** to select the MISC menu.
4. Press the **[PRINT]** key to scroll to the DATE parameter.
5. Press **[TARE]** to display current date.
- 5a. Date display Format is: dxx.xx.xx(yy-mm-dd) for LED Version, xx.xx.xx(yy-mm-dd) for LCD Version.
6. Press the **[DATA]** key for 3 seconds. The first digit of the time will flash.
7. Use the **[PRINT]** or **[N/G]** key to enter the first digit.
- 7a. If time of no operation is more than 5s, it will automatically exit modification mode.
8. Use the **[DATA]** key to move to the next digit.
9. Press the **[SETUP]** key to exit the date entry mode.

## 2.12 Display Firmware Version

---

1. Enter the Setup Mode by pressing the **[SETUP]** key more than 3 seconds.
2. Use the **[PRINT]** or **[N/G]** key to select the MISC menu.
3. Press **[TARE]** to select the MISC menu.
4. Press the **[PRINT]** key to scroll to the VER parameter.
5. Press **[TARE]** to display current version.
- 5a. Firmware Version display Format is: Vxx.yy, xx is hardware version, yy is software version.
6. Press the **[SETUP]** key to return to last menu item.
7. Press the **[ON/OFF]** key to prepare to exit this mode.

## 2.13 Display Interface Type of COM2

---

This function is used only to check whether the hardware and software about COM2 are matched.

1. Enter the Setup Mode by pressing the **[SETUP]** key more than 3 seconds.
2. Use the **[PRINT]** or **[N/G]** key to select the MISC menu.
3. Press **[TARE]** to select the MISC menu.
4. Press the **[PRINT]** key to scroll to the COM2 parameter.
5. Press **[TARE]** to display interface type of COM2.
6. Press the **[N/G]** key for more than 3 seconds to display corresponding number of COM2 hardware type setting.
7. Press the **[SETUP]** key to return to last menu item.
8. Press the **[ON/OFF]** key to prepare to exit this mode.

## 2.14 Display Test

---

1. Press the **[UNIT]** key more than 3 seconds to enter the SETUP mode.
2. Use the **[PRINT]** or **[N/G]** key to select TEST menu.
3. Press **[TARE]** to select the TEST menu.
4. Press the **[PRINT]** key to scroll to the DISP parameter.
5. Press **[TARE]** to enter the test display mode and all segments will light at first.
- 5a. In this mode, every press of the **[N/G]** key will light the next segment. Every press of the **[UNIT]** key will light the next digit.
- 5b. Press the **[TARE]** key to automatically light all segments and all digits.
6. Press the **[SETUP]** key to return to last menu item.
7. Press the **[ON/OFF]** key to prepare to exit this mode.

## 2.15 Keyboard and Buzzer Test

---

1. Enter the Setup Mode by pressing the **[SETUP]** key more than 3 seconds.
2. Use the **[PRINT]** or **[N/G]** key to select TEST menu.
3. Press **[TARE]** to select the TEST menu.
4. Press the **[PRINT]** key to scroll to the KEY parameter.
5. Press **[TARE]** to enter test keypad mode and key. -- will be displayed.
6. Press any key. The value of this key will be displayed and the buzzer will beep.
7. Press the **[SETUP]** key to return to last menu item.
8. Press the **[ON/OFF]** key to prepare to exit this mode.

## 2.16 Serial Port1/2 (COM1/2) Receiving Test

---

Before testing the receiving function of COM1 or COM2, a cable is need to connect a computer to the indicator. A terminal program such as Hyper Terminal is also needed for testing.

Note: baud rate is selected by USER-COM1/2-BAUDRT, 8N1 byte format is fixed, Hex data (0x00 - 0xff) are used.

1. Enter the Setup Mode by pressing the **[SETUP]** key more than 3 seconds.
2. Use the **[PRINT]** or **[N/G]** key to select TEST-COM1.RD or TEST-COM2.RD item.
3. Press **[TARE]** to enter test COM1/2 receiving function and rd1.-- or rd2.--will be displayed first.
  - 3a. In this mode, received hex data (0x00 - 0xff) will be displayed on -- position.
4. Press the **[SETUP]** key to return to last menu item.
5. Press the **[ON/OFF]** key to prepare to exit this mode.

## 2.17 Serial Port1/2(COM1/2) Transmitting Test

---

Before testing the transmitting function of COM1 or COM2, a cable is need to connect a computer to the indicator. A terminal program such as Hyper Terminal is also needed for testing.

Note: baud rate is selected by USER-COM1/2-BAUDRT, 8N1 byte format is fixed, Hex data (0x00 - 0xff) are used.

1. Enter the Setup Mode by pressing the **[SETUP]** key more than 3 seconds.
2. Use the **[PRINT]** or **[N/G]** key to select TEST-COM1.TD or TEST-COM2.TD item.
3. Press **[TARE]** to enter test COM1/2 receiving function and td1.-- or td2.-- will be displayed first.



- 3a. In this mode, transmitted hex data (0x00 - 0xff) will be displayed on -- position, and **[HOLD]**, **[PRINT]**, **[N/G]**, **[UNIT]** and **[TARE]** keys can be used to modify transmitted data.
4. Press the **[SETUP]** key to return to last menu item.
5. Press the **[ON/OFF]** key to prepare to exit this mode.

# 3 Setup Mode

The setup menu consists of five different sub-menus. Within each sub-menu are different menu options.

The config/cal switch must be set in the ON position in order to make changes to specific parameters.

## 3.1 Entering the Setup Menu

---

1. Power on the indicator by pressing and holding the [ON/OFF] key.
2. Press the [HOLD/SETUP] key for 3 seconds. The indicator shows " *Config*" to indicate that you are in Setup Menu mode.

## 3.2 Navigating the Setup Menu

---



1. Once in the "*Config*" menu, use the [NG/TOTAL] (up arrow) or [PRINT/FUNC] (down arrow) key to move to the next available menu in the Setup Menu.
2. Use the [TARE/PRESET] key to access the desired menu.
3. Use the [NG/TOTAL] (up arrow) or [PRINT/FUNC] (down arrow) key to choose a sub-menu (parameter).
4. Use the [TARE/PRESET] key to select the options within the sub-menu.
5. Use the [NG/TOTAL] (up arrow) or [PRINT/FUNC] (down arrow) key to make a change. Press the up or down arrow until the desired choice is on the display.
6. Press the [TARE/PRESET] key to select the

**Table 3.1 Key Navigation**

[HOLD/SETUP] ←	Access the Setup Menu.
[PRINT/FUNC] ↓	Scroll through available menus.
	Choose a sub-menu
	Make a change within the sub-menu

[NG/TOTAL] ↑	Scroll through available menus. Choose a sub-menu Make a change within the sub-menu
[UNIT/DATA] →	Choose a sub-menu
[TARE/PRESET] ←	Make a change within the sub-menu
[ZERO/ON/OFF] ↶	Exit the setup mode

### 3.3 Setup Menu Parameters

This section provides more detailed descriptions of the selections found in the Setup Menu Chart.

#### 3.3.1 Config Menu

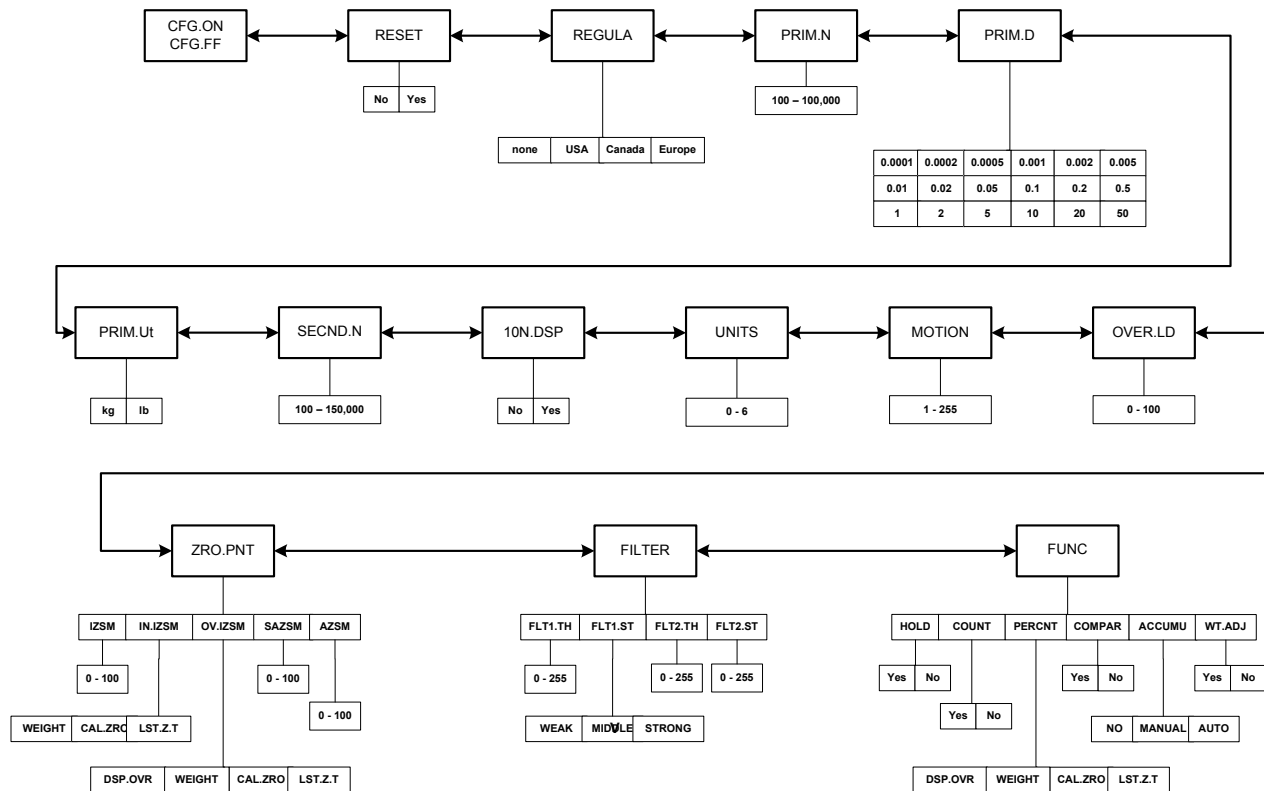

Figure 3.1 CONFIG Menu

The figure above is an illustration of the available menus with the Config menu and the choices within those menus. Refer to [Table 3.2](#) for explanations of the menu choices.

**Table 3.2 CONFIG Menu Choices and Explanations**

CONFIG				
SubMenu1	SubMenu2	Option	Default	Remark
CFG.ON CFG.OFF				seal switch is on or off
RESET		no	no	reset configure parameters to default setting
		yes		
REGULA		none	none	select the standard that the scale will comply with: USA,Canada, Europe
		USA		
		Canada		
		Europe		
PRIM.N		100 - 100,000	3000	the division number under primary unit, if (REGULAR) ≠ none, the max is 10,000
PRIM.D		0.0001	1	the division value under primary unit; the division value under second unit is automatically determined by the indicator according to the division value under primary unit.
		0.0002		
		0.0005		
		0.001		
		0.002		
		0.005		
		0.01		
		0.02		
		0.05		
		0.1		
		0.2		
		0.5		
		1		
		2		
		5		
	10			
	20			
	50			
PRIM.Ut		kg	kg	select the primary unit from kg or lb. The second unit is the lb if kg selected as primary unit or kg if lb selected as primary unit. The calibration standard weight must be in primary unit!
		lb		
SECND.N		100-150,000	3000	the division number under second unit,the max is 1.5*(PRIM.N), and if (REGULAR)≠none, the max is 10,000
10N.DSP		NO	NO	Display weight at 10 times division number under primary unit. If (REGULAR)=none this parameter will not be available.
		YES		
UNITS		0-6	3	units that can use [UNIT] key to select: 0=kg, 1=lb, 2=lb:oz, 3=kg,lb, 4=kg,lb:oz, 5=lb,lb:oz, 6=kg,lb,lb:oz
MOTION		1-255	4	Check motion window: 1-255 = ±0.25d *(1-255). If (REGULAR)=none, the max is 12

CONFIG				
SubMenu1	SubMenu2	Option	Default	Remark
OVER.LD		0-100	0	over load display limitation: 0=FS+9d, 1-100=101%FS -200%FS. If (REGULAR)=none, the max is 10
ZRO.PNT	IZSM	0-100	10	Initial zero(power on zero) point range: 0=no limitation, 1-100=(calibration zero point) $\pm$ 1%FS - (calibration zero point) $\pm$ 100%FS. If (REGULAR)=none, the max is 10
		WEIGHT	WEIGHT	Choose which weight as current initial zero point when current weight is in IZSM range: WEIGHT= current weight
		CAL.ZRO		CAL.ZRO= calibration zero
		LAST.Z.T		LAST.Z.T=switch-off zero and tare If (REGULAR) $\neq$ none, the value is fixed on WEIGHT
	OV.IZSM	DSP.OVR	DSP.OVR	Choose which weight as current initial zero point when current weight is over IZSM range: DSP.OVR=display initial zero is over; WEIGHT= current weight; CAL.ZRO= calibration zero; LAST.Z.T=switch-off zero and tare If (REGULAR) $\neq$ none, the value is fixed on DSP.OVR
		WEIGHT		
		CAL.ZRO		
		LAST.Z.T		
	SAZSM	0-100	2	Zero key range: 0=no limitation, 1-100= (initial zero point) $\pm$ 1%FS - (initial zero point) $\pm$ 100%FS, if (REGULAR) $\neq$ none, the max is 2
	AZSM	0-100	2	Zero tracking window: 0=0d, no tracking; 1-100= $\pm$ 0.25d*(1-100) / s, if (REGULAR) $\neq$ none, the max is 4
FILTER	FLT1.TH 0-255	40		Enter digital filter1 threshold: 0=no filter1; 1-254=filter1 be used only when vibration in $\pm$ 0.25d*(1-254); 255= filter1 be always used
		weak	middle	Digital filter1 intensity: weak-middle-strong
		middle		
	strong			
FLT2.TH	0-255	8	Enter digital filter2 threshold: 0=no filter2; 1-254=filter2 be used only when vibration in $\pm$ 0.25d*(1-254); 255= filter2 be always used	
FLT2.ST	0-255	240	Digital filter2 intensity: 0-255=weak to strong	
FUNC	HOLD	YES	YES	Yes/No=enable/disable hold function;
		NO		
	COUNT	YES	NO	Yes/No=enable/disable counting function,
		NO		
	PERCNT	NO	NO	Percent weighing function is enable or disable: (1)NO=disable; (2)100%=enable and display format is 100%; (3)100.0%=enable and display format is 100.0%; (4)100.00%=enable and display format is 100.00%
		100%		
		100.0%		
		100.00%		
	COMPAR	YES	YES	Yes/No=enable/disable data comparison function
		NO		
	ACCUMU	NO	NO	Accumulation Mode selection: (1)NO=no accumulation function; (2)MANUAL=add up current number to accumulation memory after TATOL key is pressed; (3)AUTO=automatically add up current number to accumulation memory after scale is stable and weight is over (NLD.RNG)
		MANUAL		
		AUTO		
WT.ADJ	YES	NO	Yes/No=enable/disable weight fine-tuning using keypad in weighing mode, if (REGULAR) $\neq$ none, this item is NO	

### 3.3.2 User Menu

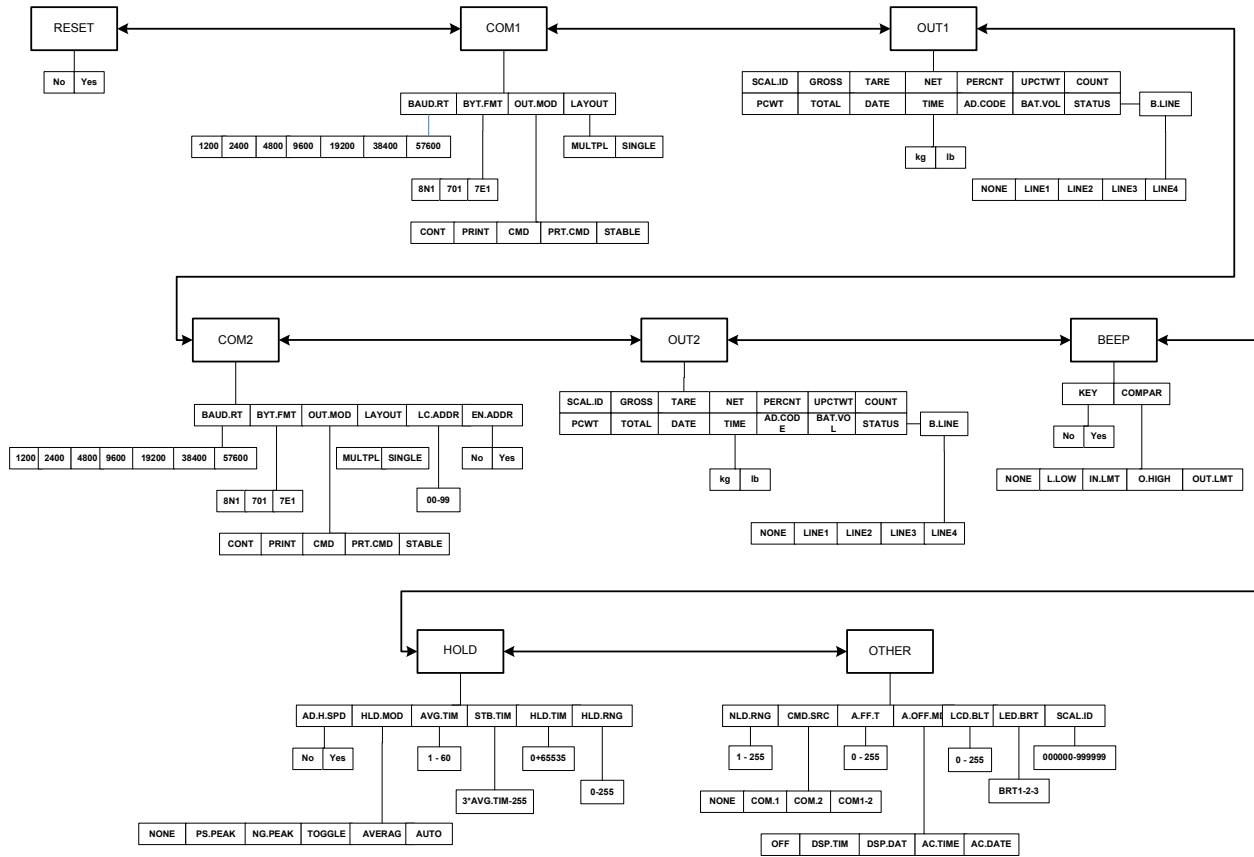

Figure 3.2 USER Menu

The figure above is an illustration of the available menus with the USER menu and the choices within those menus. Refer to [Table 3.3](#) for explanations of the menu choices.

**Table 3.3 User Menu Choices and Explanations**

USER					
SubMenu1	SubMenu2	Option	Default	Remark	
RESET		NO	NO	reset user parameters to default setting	
		YES			
COM1	BAUD.RT	1200	9600	selection of com1 baud rate	
		2400			
		4800			
		9600			
		19200			
		38400			
		57600			
	BYT.FMT	8N1	8N1	8N1	selection of com1 byte format
			7O1		
			7E1		
	OUT.MOD	CONT	PRT.CMD	PRT.CMD	Selection com1 output mode: (1)CONT=continuously output
			PRINT		(2)PRINT=output after PRINT key pressed
			CMD		(3)CMD=output after a request command is received
			PRT.CMD		(4)PRT.CMD= output after PRINT key pressed or request command received
STABLE			(5)STABLE=output after scale is stable; Note: use PRINT or CMD to output data, the scale must be stable		
LAYOUT	MULTPL	MULTPL	MULTPL	com1 output content and format set: (1)MULTPL= the following selected item in OUT1 will be output use defined format	
		SINGLE		(2)SINGLE= only displayed content and current status will be output, it's compatible with NCI-SCP01	

USER				
SubMenu1	SubMenu2	Option	Default	Remark
OUT1	SCAL.ID	YES	NO	Yes/No=enable/disable output scale's ID number, Prompt is "SCALE ID"
		NO		
	GROSS	YES	NO	Yes/No=enable/disable output gross weight. Prompt is "GROSS"
		NO		
	TARE	YES	NO	Yes/No=enable/disable output tare weight. Prompt is "TARE"
		NO		
	NET	YES	YES	Yes/No=enable/disable output net weight. Prompt is "NET"
		NO		
	PERCNT	YES	NO	Yes/No=enable/disable output weight percentage. Prompt is "PERCENTAGE"
		NO		
	UPCTWT	YES	NO	Yes/No=enable/disable output weight of 1% percentage. Prompt is "1% REF WT"
		NO		
	COUNT	YES	NO	Yes/No=enable/disable output counts. Prompt is "QUANTITY"
		NO		
	PCWT	YES	NO	Yes/No=enable/disable output piece weight. Prompt is "PIECE WT"
		NO		
	TOTAL	YES	NO	Yes/No=enable/disable output accumulation times and total. Prompt is "ACC. N" and "TOTAL"
		NO		
	DATE	YES	NO	Yes/No=enable/disable output date. Prompt is "DATE"
		NO		
TIME	YES	NO	Yes/No=enable/disable output time. Prompt is "TIME"	
	NO			
AD.CODE	YES	NO	Yes/No=enable/disable output ADC's code. Prompt is "A/D CODE"	
	NO			
BAT.VOL	YES	NO	Yes/No=enable/disable output voltage of battery. Prompt is "VOLTAGE"	
	NO			
STATUS	YES	NO	Yes/No=enable/disable output scale's status. Prompt is "STATUS"	
	NO			
B.LINE	NONE	LINE1	How many blank lines after strings output: NONE=no blank line, LINE1/2/3/4=there're 1, 2,3 or 4 blank lines after strings, used for paper feed forward 1/2/3/4 lines.	
	LINE1			
	LINE2			
	LINE3			
	LINE4			



USER				
SubMenu1	SubMenu2	Option	Default	Remark
COM2	BAUD.RT	1200	9600	selection of com2 baud rate
		2400		
		4800		
		9600		
		19200		
		28800		
		57600		
	BYT.FMT	8N1	8N1	selection of com2 byte format: (1)8N1=8 data bits, No parity check bit, 1 stop bit; (2)7O1=7 data bits, 1 Odd parity check bit, 1 stop bit; (3)7E1=7 data bits, 1 Even parity check bit, 1 stop bit;
		7O1		
		7E1		
	OUT.MOD	CONT	PRT.CMD	Selection com1 output mode: (1)CONT=continuously output (2)PRINT=output after PRINT key pressed (3)CMD=output after a request command is received (4)PRT.CMD= output after PRINT key pressed or request command received (5)STABLE=output after scale is stable; Note: use PRINT or CMD to output data, the scale must be stable
		PRINT		
		CMD		
		PRT.CMD		
		STABLE		
	LAYOUT	MULTPL	MULTPL	com2 output content and format set: (1)MULTPL= the following selected item in OUT2 will be output use defined format (2)SINGLE= only displayed content and current status will be output, it's compatible with NCI-SCP01
		SINGLE		
LC.ADDR	00-99	01	Local address for COM2	
EN.ADDR	NO	NO	Yes/No=enable/disable using com2 local address in output or input strings	
	YES			

USER				
SubMenu1	SubMenu2	Option	Default	Remark
OUT2	SCAL.ID	YES	NO	Yes/No=enable/disable output scale's ID number, Prompt is "SCALE ID"
		NO		
	GROSS	YES	NO	Yes/No=enable/disable output gross weight. Prompt is "GROSS"
		NO		
	TARE	YES	NO	Yes/No=enable/disable output tare weight. Prompt is "TARE"
		NO		
	NET	YES	YES	Yes/No=enable/disable output net weight. Prompt is "NET"
		NO		
	PERCNT	YES	NO	Yes/No=enable/disable output weight percentage. Prompt is "PERCENTAGE"
		NO		
	UPCTWT	YES	NO	Yes/No=enable/disable output weight of 1% percentage. Prompt is "1% REF WT"
		NO		
	COUNT	YES	NO	Yes/No=enable/disable output counts. Prompt is "QUANTITY"
		NO		
	PCWT	YES	NO x	Yes/No=enable/disable output piece weight. Prompt is "PIECE WT"
		NO		
	TOTAL	YES	NO	Yes/No=enable/disable output accumulation times and total. Prompt is "ACC. N" and "TOTAL"
		NO		
	DATE	YES	NO	Yes/No=enable/disable output date. Prompt is "DATE"
		NO		
TIME	YES	NO	Yes/No=enable/disable output time. Prompt is "TIME"	
	NO			
AD.CODE	YES	NO	Yes/No=enable/disable output ADC's code. Prompt is "A/D CODE"	
	NO			
BAT.VOL	YES	NO	Yes/No=enable/disable output voltage of battery. Prompt is "VOLTAGE"	
	NO			
STATUS	YES	NO	Yes/No=enable/disable output scale's status. Prompt is "STATUS"	
	NO			
B.LINE	NONE	LINE1	How many blank lines after strings output: NONE=no blank line, LINE1/2/3/4=there're 1, 2,3 or 4 blank lines after strings, used for paper feed forward 1/2/3/4 lines.	
	LINE1			
	LINE2			
	LINE3			
	LINE4			

USER				
SubMenu1	SubMenu2	Option	Default	Remark
BEEP	KEY	YES	YES	Yes/No=enable/disable beep after a key pressed down
		NO		
	COMPAR	NONE	IN.LMT	(1)NONE = no beep
		L.LOW		(2)L.Low = beep when lower than low limitation;
		IN.LMT		(3)IN.LMT = beep when in range of low and high limitation
		O.HIGH		(4)O.HIGH = beep when over high limitation
	OUT.LMT		(5)OUT.LMT = beep when lower than low limitation or higher than high limitation	
HOLD	AD.H.SPD	YES	NO	Yes/No=enable/disable use high speed of A/D converter after entering HOLD mode
		NO		
	HLD.MOD	NONE	AUTO	HOLD Mode: (1)NONE=no hold function
		PS.PEAK		(2)PS.PEAK=Positive Peak number Hold mode: scale will display and refresh the positive peak value from last zero setting
		NG.PEAK		(3)NG.PEAK=Negative PEAK number Hold mode. it's Similar with PS.PEAK, but negative number is used.
		TOGGLE		(4)TOGGLE=Press HOLD key to enter HOLD mode, if weight is over (NLD.RNG) and stable, the data will be frozen until press HOLD key again to exit.
		AVERAG		(5) AVERAG= Average HOLD mode:in this mode, if weight is over (NLD.RNG), and its variation is less than (DYN.RNG), the average data in (AVG.TIM) will be frozen. Press HOLD key or (HLD.TIM) time elapsed to exit this mode
		AUTO		(6)AUTO=Auto hold mode: it's similar with AVERAG mode, but if the one held load is removed, and a new load that is over (NLD.RNG) put on scale, the new load will be automatically frozen.
	AVG.TIM	1-60	3	average data time for HOLD mode: 1-60s
	STB.TIM	3*AVG.TIM - 255	3* AVG.TIM	Waiting time for scale stable in HOLD mode: 3*(AVG.TIM) - 255S
	HLD.TIM	0-65535	0	Data HOLD time: 0=data will be frozen until HOLD key pressed; 1-65535=data frozen time is 1-65535s, after the time elapses, scale will exit HOLD mode
HLD.RNG	0 - 255	5	Vibration range of data that can be averaged and held in HOLD mode:0=any data can be averaged; 1-255= only the data which vibration is in 1-255d can be averaged and held;	

USER					
SubMenu1	SubMenu2	Option	Default	Remark	
OTHER	NLD.RNG	1-255	10	1-255=the range of weight is 1-255d; when current weight is less than this value, the scale can be regarded as empty, or the load on scale is removed. It must be bigger than (CONFI.MOTION).	
	CMD.SRC	NONE	COM.1	Source of the executed command selection: (1)NONE=no any command will be executed; (2)COM.1= command from COM1 will be executed; (3)COM.2= command from COM2 will be executed; (4)COM.1.2= command from COM1 or COM2 will be executed;	
		COM.1			
		COM.2			
		COM1-2			
	A.OFF.T	0-255	5	Auto off time: 0=not auto power off; 1-255=auto power off after 1-255 minutes, in this period, no operation or no weight changing	
	A.OFF.MD	OFF	AC.TIME		Auto off mode: (1)OFF=turn off instrument
		DSP.TIM			(2)DSP.TIM= display time
		DSP.DAT			(3)DSP.DAT=display date
		AC.TIME			(4)AC.TIME=turn off when only battery is used, display time when AC adaptor is used
AC.DATE		(5)AC.DATE=turn off when only battery is used, display date when AC adaptor is used			
LCD.BLT	0-255	30	LCD backlight set: (1)0=always off (2)1=always on (2)2=press down ZERO+UNIT together more than 3s to turn on or turn off (4)3-255=auto on when key operation or weight changing, auto off after 3-255s elapsed; only available on LCD version		
LED.BRT	BRT1-2-3	BRT2	LED brightness level set: BRT1-BRT2-BRT3=low - middle - high; only available on LED version		
SCAL.ID	000000-999999	123456	scale's ID number: 000000-999999		

### 3.3.3 Cal Menu

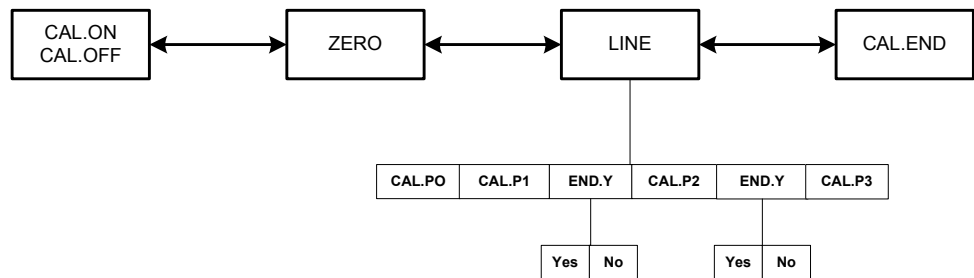

Figure 3.3 CAL Menu

The figure above is an illustration of the available menus with the CAL menu and the choices within those menus. Refer to [Table 3.4](#) for explanations of the menu choices.

**Table 3.4 CAL Menu Choices and Explanations**

CAL				
Submenu1	Submenu2	Option	Remark	
CAL.ON CAL.OFF			seal switch is on or off	
ZERO			only do zero point calibration, then go to CAL.END to end	
LINE	CAL.P0		line calibration point0: do zero point calibration, this point can't be omitted.	
	CAL.P1		line calibration point1: do first weight point calibration, this point can't be omitted and standard weight must be over 10%FS.	
	END.Y	YES		End calibration? YES=go to CAL.END to end; NO=go to do next point calibration
		NO		
	CAL.P2		line calibration point2: do second weight point calibration, standard weight must be over 10%FS and be larger than it in CAL.P1, this point can be omitted.	
	END.Y	YES		End calibration? YES=go to CAL.END to end; NO=go to do next point calibration
NO				
CAL.P3		line calibration point3: do third weight point calibration, standard weight must be over 10%FS and be larger than it in CAL.P2, this point can be omitted.		
CAL.END			calibration end and restart	

### 3.3.4 Misc Menu

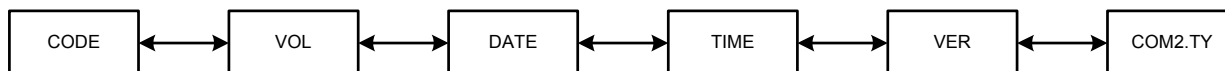

**Figure 3.4 MISC Menu**

The figure above is an illustration of the available menus with the MISC menu. There are no programming choices within this menu. Refer to [Table 3.5](#) for explanations of the menu choices.

**Table 3.5 MISC Menu Choices and Explanations**

MISC	
Submenu1	Remark
CODE	display ADC's code, this code can be after no-filter, filter1 or filter2
VOL	display voltage; calibrate voltage; set full charged voltage and low battery voltage
DATE	display date and set date
TIME	display time and set time
VER	display firmware version
COM2.TY	display interface type of COM2

### 3.3.5 Test Menu

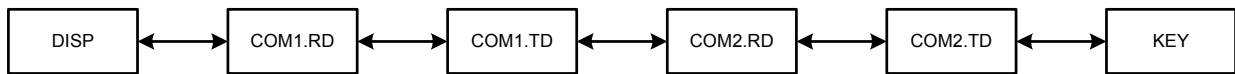

**Figure 3.5 TEST Menu**

The figure above is an illustration of the available menus with the TEST menu. There are no programming choices within this menu. Refer to [Table 3.6](#) for explanations of the menu choices.

**Table 3.6 TEST Menu Choices and Explanations**

TEST	
Submenu1	Remark
DISP	test LCD or LED
COM1.RD	test COM1 receiving
COM1.TD	test COM1 transmitting
COM2.RD	test COM2 receiving
COM2.TD	test COM2 transmitting
KEY	test keys and buzzer

## 3.4 Exit the Setup Menu

1. Power off the indicator by pressing and holding the **[ZERO/off]** key.
2. Move the slide switch on the rear cover back to the left and replace the metal protective plate. Refer to section 3.2 for location.
3. Turn the indicator back on by pressing the **[ON]** key. The display will go through a digit check, then settle into Normal Operating mode. All front panel keys will now return to their normal mode of operation.

## 4 Calibration

The config/cal switch must be set to the ON position in order to calibrate the indicator.

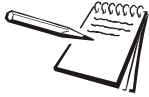

---

*NOTE: More than 10% of the full scale weight is needed for calibration.*

---

### 4.1 Calibration Mode

---

1. Access the setup mode by pressing the **[SETUP]** key for 3 seconds.
2. Use the **[PRINT]** key to select the CAL menu.
3. Press the **[TARE]** key to enter the calibration mode.
- 3a. After entering this mode, the number of calibrations will be shown first. This number will be increment one digit after every calibration and calibration data saved. This counter can't be modified or erased. It counts from 0000 to 9999, when it reaches 9999, it starts over at 0000.
4. After the counter number was displayed, it will show "CAL.OFF" or "CAL-ON" which depends on whether the sealed calibration switch is OFF or ON. If the switch is OFF, the following steps can be done, but the result will not be saved.
5. Press the **[TARE]** key to go to next step.

#### Zero Point

1. When ZERO is displayed, remove all weight on the scale.
2. Press the **[TARE]** key to select zero point calibration.
3. The ZERO will flash while capturing the zero point. After getting reasonable data, it automatically saves the change and exits to the weigh mode.

#### Linearity

The scale linearity can be calibrated with a zero reference and a full scale reference or multiple linearity weight values. The linearity calibration is determined by the settings in the CAL-LINE parameter.

1. When LINE is selected, press the **[TARE]** key to enter linearity calibration.
2. CAL.P0 will be displayed with a zero value. Remove all weight on the scale and then press the **[TARE]** key to confirm zero point calibration. The zero weight will flash while capturing the zero point. After getting the reasonable zero-point data, the zero weight will become steady and then go to next step.
3. When first default standard weight is displayed after CAL.P1 being shown. The default standard weight is 100%FS. Use the **[HOLD]**, **[PRINT]**, **[N/G]**, **[UNIT]** keys to input the value of the loaded weight.
4. Put corresponding weight (more than 10%FS weight) onto scale.

5. Press the **[TARE]** key to confirm the calibration.
- 5a. The indicator will flash the input standard weight. When the weight becomes steady the indicator will automatically go to next step. If this point can't be calibrated correctly CAL.Er will be displayed. It is possible the weight load onto scale is too small or the input data is incorrect. Repeat the previous steps.
6. When End.y is shown and the y is flashing, it's waiting command to exit calibration or go on next calibration point. Use the **[PRINT]** or **[N/G]** key to select yes or no.
7. Press the **[TARE]** key to confirm.
- 7a. If yes is selected, the calibration will be saved and exit to the weigh mode.
- 7b. If no is selected, it will go to next step.
8. When first default standard weight is displayed after CAL.P2 being shown. The default standard weight is 100%FS. Use the **[HOLD]**, **[PRINT]**, **[N/G]**, **[UNIT]** keys to input the value of the loaded weight (more than 10%FS weight, and larger than the weight used on CAL.P1) onto scale.
9. When End.y is shown and the y is flashing, it's waiting command to exit calibration or go on next calibration point. Use the **[PRINT]** or **[N/G]** key to select yes or no.
10. Press the **[TARE]** key to confirm.
11. When first default standard weight is displayed after CAL.P3 being shown. The default standard weight is 100%FS. Use the **[HOLD]**, **[PRINT]**, **[N/G]**, **[UNIT]** keys to input the value of the loaded weight (more than 10%FS weight, and larger than the weight used on CAL.P2) onto scale.
12. Press the **[TARE]** key to confirm.
13. When calibration is complete CAL.End will be displayed. The indicator will re-start and go back to the weigh mode.

## 4.2 Weight Fine-tune

---

With this function, the user can adjust displayed weight a little, and no need standard weight. But please note:

- The scale must have been calibrated previously
  - The range of adjustment is "(current displayed weight) x (0.9-1.1)". it means the range is about  $\pm 10\%$
  - The CONFIG-REGULA =NONE and CONFIG-FUNC-WT.ADJ=YES must be set.
1. To enter this mode, turn on indicator. After the indicator displays a 0 weight, place weight onto scale. The indicator will display the weight.
  2. Press down **[TARE]** and **[ZERO]** at same time until first digit flashes, this means indicator has entered into "weight fine-tune" mode.
  3. Use the arrow keys to input correct weight.
  4. Press the **[TARE]** key to confirm. The active correct weight will be displayed.



## 4.3 Display ADC Output Code

---

In this mode, you can examine the stability of weighing system and increment the ADC output code corresponding to the loaded weight.

Note:

- The increment of ADC code for full scale weight must be larger or equal to 10 times of selected display division. Otherwise, the calibration cannot be properly completed.
    - e.g. The display division is 0.1kg. Load 100kg standard weight on the platform, the increment of ADC code should be at least more than  $10 \times 100\text{kg} / 0.1\text{kg} = 10 \times 1000 = 10000$ . In this case, the scale can be calibrated. Otherwise, smaller division needs to be chosen.
  - The variation of the ADC code should be small. Otherwise, the calibration cannot be properly completed.
1. From the weigh mode press the **[SETUP]** key until CONFIG is shown.
  2. Use the **[PRINT]** or **[N/G]** key to go to MISC - Code.
  3. Press the **[TARE]** key to enter this mode and display the ADC output raw code.
  4. Press the **[TARE]** key to set the current code as a reference zero and then display net code
  5. Press **[TARE]** again to clear this reference and display gross code. From the net code mode, press the **[N/G]** key to select net or gross code to display, not clear the reference code.
  6. In this mode, press the **[UNIT]** key to select displaying code that has been filtered by no-filter, filter1 or filter1 and filter2 and corresponding annunciator LO, OK, HI will be illuminated.
  7. Press the **[SETUP]** key to return to last menu item.
  8. Press the **[ON/OFF]** key to exit this mode

## 4.4 Display and Calibrate Power Voltage

---

In this mode, you can examine the voltage of battery or the voltage from the AC adaptor when no battery is used. You can also calibrate the displayed voltage and set the voltage value of low battery point.

Note:

- The end customer normally has no need to set the value of low battery and full-charged voltage, calibrate the displayed voltage, these have been done in factory.
  - The normal displaying voltage is 5.6V-7.6V
1. From the weigh mode press the **[SETUP]** key until CONFIG is shown.
  2. Use the **[PRINT]** or **[N/G]** key to go to MISC - Vol.
  3. Press the **[TARE]** key to enter this mode and display the battery voltage.

### **If the voltage is not correct**

Calibrate the voltage according to following steps:

1. Prepare a DC power supply which output voltage can be adjusted from 5V to 8V (output current must be larger than 0.5A). Power off the indicator and unplug the AC adaptor.
2. Connect the DC power to battery connector on main board. Adjust the voltage to about 6V
3. Turn on the indicator with the **[ON/OFF]** key.
1. From the weigh mode press the **[SETUP]** key until CONFIG is shown.
2. Use the **[PRINT]** or **[N/G]** key to go to MISC - Vol.
3. Press the **[TARE]** key to enter this mode and display the battery voltage.
4. Press down the **[UNIT]** key until CAL.6V is shown.
5. To adjust the voltage to 6V, press the **[TARE]** key to confirm 6V calibration.
6. When CAL.7V is shown, adjust voltage to 7V. Press the **[TARE]** key to confirm 7V calibration. When CV.End is shown, that means the voltage calibration is completed and then exit to display voltage.
7. In displaying voltage mode, press the **[N/G]** key more than 3 seconds.
8. When LoV. 5.6 is shown, use the **[PRINT]** or **[N/G]**, **[UNIT]** keys to input new value (5.6V is default, input range is 5.2V-5.8V).
9. Press the **[TARE]** key to confirm and exit to display voltage.
10. Press the **[SETUP]** key to return to last menu item.
11. Press the **[ON/OFF]** key to exit this mode.

# 5 Serial Communication

## 5.1 Com Port 1

---

COM1 is a RS-232 bid-directional port. Communication wires are connected to the RS-232 connector using TXD1, RXD1 and GND. Refer to [page 7](#) for connection details.

## 5.2 Com Port 2

---

COM2 can be RS232 or RS485, if used as RS232, communication wires come from RS232 connector, and TXD2, RXD2 and GND are used, if used as RS485, communication wires come from RS485 connector, and A and B are used (if need GND or +5VCC1 can be used).

Please refer to section 22.2, 22.3.4-5, 22.3.7-9 for jumper connector details.

## 5.3 Protocol

---

The baud rate and byte format is set by USER-COM1/2-BAUD.RT and USER-COM1/2-BYT.FMT.

Responses to serial commands will be immediate, or within one weight measure cycle of the scale. One second should be adequate for use as a time-out value by remote (controlling) device.

## 5.4 Transaction String

---

The length of each item in a transition string:

- Reading data --- 6bytes
- Data polarity ----1byte: "-" for negative, and followed the first digit; " " for positive.
- Decimal point ---1byte: "."
- Measure unit ----1-5bytes:" lb"," kg","lb:oz","pcs","%", Units are always lower case, left aligned
- Current status-- 4bytes
  - If the weight is over capacity, the scale will return eight "^" characters (the field of polarity, decimal point, weight data is filled by "^").
  - If the weight is under capacity, it will return eight "\_" characters (the field of polarity, decimal point, and weight data is filled by "\_").
  - If the zero point is error, it will return eight "-" characters (the field of polarity, decimal point, and weight data is filled by "-").

Useless leading 0 before digits is suppressed, reading weight is right aligned.

**Table 5.1 Symbols Used**

<LF>	Line Feed character (hex 0AH)
<CR>	Carriage Return character (hex 0DH)
<ETX>	End of Text character (hex 03H)
<SP>	Space (hex 20H)
H <sub>1</sub> H <sub>2</sub> H <sub>3</sub> H <sub>4</sub>	Four current status bytes
<P>	Polarity character: "?" or " "
W 1--W6	Reading data, 1-6 bytes (six digits)
<DP>	Decimal point
U <sub>1</sub> U <sub>2</sub> U <sub>3</sub> U <sub>4</sub> U <sub>5</sub>	Measure units, kg, lb, lb:oz , % or pcs; 2-5 bytes
<Add>	Address of scale; 2 bytes (00-99)
<Prompt>	Prompt characters of output content; max. 11bytes

**Table 5.2 Bit Definition of H<sub>1</sub>H<sub>2</sub>H<sub>3</sub> H<sub>4</sub>**

Bit	Byte 1 (H <sub>1</sub> )	Byte 2 (H <sub>2</sub> )	Byte 3 (H <sub>3</sub> )	Byte 4 (H <sub>4</sub> )
0	0 = stable	0 = not under capacity	00 = compare disable 01 = lower limit 10 = ok 11= upper limit	00 = normal weighing 01 = count weighing 10 = percent weighing 11 = other mode
	1 = not stable	1 = under capacity		
1	0 = not at zero point	0 = not over capacity		
	1 = at zero point	1 = over capacity		
2	0 = RAM ok	0 = ROM ok	0 = gross weight	0 = not in HOLD
	1 = RAM error	1 = ROM error	1 = net weight	1 = in HOLD
3	0 = eeprom OK	0 = calibration ok	0 = initial zero ok	0 = battery ok
	1 = eeprom error	1 =c alibration error	1 = initial zero error	1 = low battery
4	always 1	always 1	always 1	always 1
5	always 1	always 1	always 1	always 1
6	always 0	always 1	always 1	always 0
7	parity	Parity	parity	Parity

## 5.5 Commands and response

---

Set the USER-Com 1/2-LAYOUT parameter

## 5.5.1 Single

### Command: W<CR> (57h 0dh), request current reading

Response
<LF>^^^^^^U <sub>1</sub> U <sub>2</sub> U <sub>3</sub> U <sub>4</sub> U <sub>5</sub> <CR><LF> H <sub>1</sub> H <sub>2</sub> H <sub>3</sub> H <sub>4</sub> <CR><ETX>---over capacity
<LF>_____ U <sub>1</sub> U <sub>2</sub> U <sub>3</sub> U <sub>4</sub> U <sub>5</sub> <CR><LF> H <sub>1</sub> H <sub>2</sub> H <sub>3</sub> H <sub>4</sub> <CR><ETX>---under capacity
<LF>----- U <sub>1</sub> U <sub>2</sub> U <sub>3</sub> U <sub>4</sub> U <sub>5</sub> <CR><LF> H <sub>1</sub> H <sub>2</sub> H <sub>3</sub> H <sub>4</sub> <CR><ETX>---zero-point error
Note: U <sub>1</sub> U <sub>2</sub> U <sub>3</sub> U <sub>4</sub> U <sub>5</sub> is 1,2,3 or 5 bytes according to current unit: %, kg, lb, pcs, lb:oz
<LF><P>W <sub>1</sub> W <sub>2</sub> W <sub>3</sub> W <sub>4</sub> W <sub>5</sub> <DP>W <sub>6</sub> U <sub>1</sub> U <sub>2</sub> U <sub>3</sub> U <sub>4</sub> U <sub>5</sub> <CR><LF> H <sub>1</sub> H <sub>2</sub> H <sub>3</sub> H <sub>4</sub> <CR><ETX>---normal data
Note: (1) The decimal point position is determined by CONFIG-PRIM.D (2) If current unit is "lb:oz", the format will be similar with following:
<LF><P>W <sub>1</sub> W <sub>2</sub> W <sub>3</sub> lb<SP>W <sub>4</sub> W <sub>5</sub> <DP>W <sub>6</sub> oz<CR><LF> H <sub>1</sub> H <sub>2</sub> H <sub>3</sub> H <sub>4</sub> <CR><ETX>

### Command: S<CR> (53h 0dh), request current status

Response
<LF> H <sub>1</sub> H <sub>2</sub> H <sub>3</sub> H <sub>4</sub> <CR><ETX>

### Command: Z<CR> (5ah 0dh)

Response
Zero function is activated (simulate ZERO key) and it returns to current scale status.
<LF> H <sub>1</sub> H <sub>2</sub> H <sub>3</sub> H <sub>4</sub> <CR><ETX>

If ZERO function cannot be activated, it will return to current scale status.

### Command: T<CR> (54h 0dh)

Response
TARE function is activated (simulate TARE key), and then returns scale status.
<LF> H <sub>1</sub> H <sub>2</sub> H <sub>3</sub> H <sub>4</sub> <CR><ETX>

If TARE function cannot be activated, it will return to current scale status.

**Command: U<CR> (55h 0dh)**

Response
Changes units of measure (simulate UNIT key) and return scale status with new units, The new measure unit should be allowed to use
<LF> U <sub>1</sub> U <sub>2</sub> U <sub>3</sub> U <sub>4</sub> U <sub>5</sub> <CR><LF> H <sub>1</sub> H <sub>2</sub> H <sub>3</sub> H <sub>4</sub> <CR><ETX>

**Command: L<CR> (4ch 0dh)**

Response
If Hold function can be activated, it will enable/disable hold function (simulate HOLD key) and returns scale status.
<LF> H <sub>1</sub> H <sub>2</sub> H <sub>3</sub> H <sub>4</sub> <CR><ETX>

**Command: X<CR> (58h 0dh)**

Response
Power off the scale, just like press down the ON/OFF key to turn off the scale.

**Command: all others**

Response
Unrecognized command
<LF>? <CR><ETX>

**Table 5.3 Summary of Command and Response:**

Command		Response
ASCII	HEX	
W<CR>	57 0d	Read scale weight: <LF>^U <sub>1</sub> U <sub>2</sub> U <sub>3</sub> U <sub>4</sub> U <sub>5</sub> <CR><LF> H <sub>1</sub> H <sub>2</sub> H <sub>3</sub> H <sub>4</sub> <CR><ETX>---over capacity ?<LF> _____ U <sub>1</sub> U <sub>2</sub> U <sub>3</sub> U <sub>4</sub> U <sub>5</sub> <CR><LF> H <sub>1</sub> H <sub>2</sub> H <sub>3</sub> H <sub>4</sub> <CR><ETX>---under capacity ?<LF>----- U <sub>1</sub> U <sub>2</sub> U <sub>3</sub> U <sub>4</sub> U <sub>5</sub> <CR><LF> H <sub>1</sub> H <sub>2</sub> H <sub>3</sub> H <sub>4</sub> <CR><ETX>---zero-point error ?<LF><p>W <sub>1</sub> W <sub>2</sub> W <sub>3</sub> W <sub>4</sub> W <sub>5</sub> <dp>W <sub>6</sub> U <sub>1</sub> U <sub>2</sub> U <sub>3</sub> U <sub>4</sub> U <sub>5</sub> <CR><LF>H <sub>1</sub> H <sub>2</sub> H <sub>3</sub> H <sub>4</sub> <CR><ETX>---normal data
S<CR>	53 0d	<LF> H <sub>1</sub> H <sub>2</sub> H <sub>3</sub> H <sub>4</sub> <CR><ETX>; read scale status
Z<CR>	5a 0d	<LF> H <sub>1</sub> H <sub>2</sub> H <sub>3</sub> H <sub>4</sub> <CR><ETX>; simulate ZERO key
T<CR>	54 0d	<LF> H <sub>1</sub> H <sub>2</sub> H <sub>3</sub> H <sub>4</sub> <CR><ETX>; simulate TARE key
U<CR>	55 0d	<LF> U <sub>1</sub> U <sub>2</sub> U <sub>3</sub> U <sub>4</sub> U <sub>5</sub> <CR><LF> H <sub>1</sub> H <sub>2</sub> H <sub>3</sub> H <sub>4</sub> <CR><ETX>; simulate UNIT key
L<CR>	4c 0d	<LF> H <sub>1</sub> H <sub>2</sub> H <sub>3</sub> H <sub>4</sub> <CR><ETX>; simulate HOLD key
X<CR>	58 0d	power off the scale, simulate OFF key
others		<LF>? <CR><ETX>

## 5.5.2 Multiple

Output string frame
<LF><Add><Prompt><p>W <sub>1</sub> W <sub>2</sub> W <sub>3</sub> W <sub>4</sub> W <sub>5</sub> <Dp>W <sub>6</sub> U <sub>1</sub> U <sub>2</sub> U <sub>3</sub> U <sub>4</sub> U <sub>5</sub> <CR>
---- Line number and content are determined by setting of USER-OUT1/2-xxxx
<LF><Add><Prompt>H <sub>1</sub> H <sub>2</sub> H <sub>3</sub> H <sub>4</sub> <CR> ---- USER-OUT1/2-STATUS is set to YES
<LF><Add><CR> --- USER-OUT1/2-LINE is set to LINE1/2/3/4
---The number of blank lines is determined by USER-OUT1/2-LINE setting
<ETX> --- Last byte of string frame

### Caution

- The decimal point position is determined by the CONFIG-PRIM.D parameter
- The unit position and bytes is determined by which current unit is used.
- The details of <Prompt> refer to the content in 4.3USER Submenu.
- If USER-COM2-EN.ADDR is set to NO, no <Add> will be output.
- In hold mode, if ADC conversion speed is set to high speed (80Hz), USER-COM1/2-LAYOUT is set to MULTIPLE and many transmissions are selected to output, the output contents from COM1 or COM2 may not catch up with the data processed in indicator, If you want to watch "real time" data, you need to select fewer output contents and set higher baud rate for COM1 or 2.

### Example Layouts

When USER-OUT1/2-xxxx is set to YES (USER-COM2-EN.ADDR=No):

### Weighing Mode:

```

SCALE ID:      123456
GROSS:         123lb 4.56oz
TARE:          11lb 2.22oz
NET:           112lb 2.34oz
ACC. N:        8
TOTAL:         789lb 15.2oz
DATE:          2011-06-12
TIME:          12:34:56
A/D CODE:      1234567
VOLTAGE:       6.7V
STATUS:        bpg2

```

**Counting Mode:**

SCALE ID: 123456  
GROSS: 1234.55kg  
TARE: 12.15kg  
NET: 1222.40kg  
QUANTITY: 24448pcs  
PIECE WT: 0.05kg  
ACC. N: 10  
TOTAL: 23456pcs  
DATE: 2011-06-12  
TIME: 12:34:56  
A/D CODE: 1234345  
VOLTAGE: 6.7V  
STATUS: bpq2

**Percent weighing mode:**

SCALE ID: 123456  
GROSS: 12345lb  
TARE: 10lb  
NET: 12335lb  
PERCENTAGE: 91.4%  
1% REF. WT: 135lb  
ACC. N: 3  
TOTAL: 271.6%  
DATE: 2011-06-12  
TIME: 12:34:56  
A/D CODE: 1231234  
VOLTAGE: 6.7V  
STATUS: bpq2



## 6 Legal for Trade

The Model SBI-521 must be configured to meet regulations mandated by local weights and measures authorities.

### 6.1 Configuration/Calibration Switch

---

The configuration/calibration switch is used to protect the indicator from being configured or calibrated under legal for trade conditions. When set to legal for trade and sealed with a lead seal, the indicator can only be configured and calibrated by authorized personnel.

The switch is located under the triangle plate on the back panel. Remove the three screws which hold the cover on.

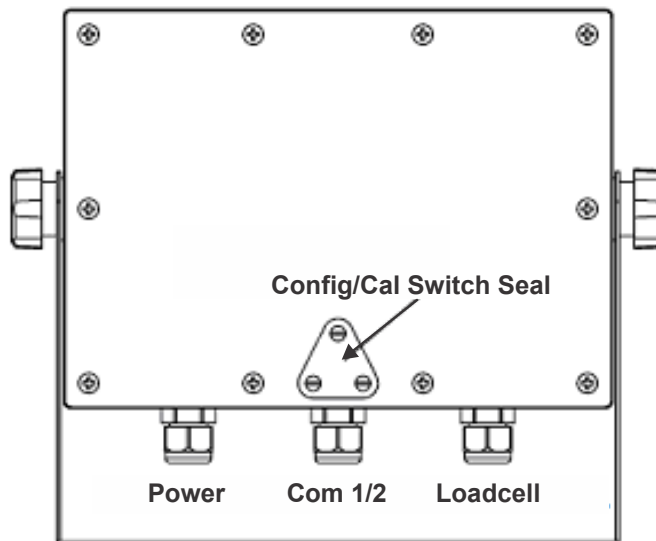

The switch must be set in the ON position (switch is to the left).

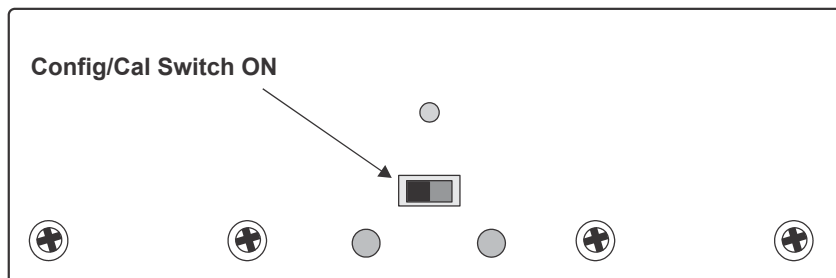

### 6.2 Audit Trail Parameters

---

Two separate incrementing, non-resetable audit trail parameters are used by the Model SBI-521 to indicate changes to various parameters or calibration.

## **6.2.1 View Configuration Counter**

---

1. Press and hold the **[SETUP]** key for 3 seconds. CONFIG is displayed
2. Press the **[TARE]** key.
- 2a. The display will briefly show the number of times the configuration has been changed and saved up to 999

### **To Exit:**

1. Press the **[ON/OFF]** key. Exit? is displayed
2. Press the **[TARE]** key to return to weigh mode

## **6.2.2 View Calibration Counter**

---

1. Press and hold the **[SETUP]** key for 3 seconds. CONFIG is displayed
2. Press the **[FUNC]** key twice. Cal is displayed
3. Press the **[TARE]** key
- 3a. The display will briefly show the number of times the configuration has been changed and saved up to 999

### **To Exit:**

1. Press the **[ON/OFF]** key. Exit? is displayed
2. Press the **[TARE]** key to return to the weigh mode

# 7 Specifications

## 7.1 SBI-521 Series Models

Model	Description
SBI-521E	LED Version, no battery, Serial port2 is Rs232 or RS485
SBI-521C	LCD Version, no battery, Serial port2 is Rs232 or RS485
SBI-521EB	LED Version, 6V2.8AH lead-acid rechargeable battery is installed
SBI-521CB	LCD version, 6V2.8AH lead-acid rechargeable battery is installed

## 7.2 Housing and Outline Dimension

### 7.2.1 Housing

IP65 wash-down stainless steel housing with rotary bracket.

### 7.2.2 Outline Dimension

- With bracket: 10.31" x 8.46" x 3.45" (262mm x 215mm x 85mm)
- Without bracket: 8.66" x 6.30" x 3.07" (220mm x 160mm x 78mm)

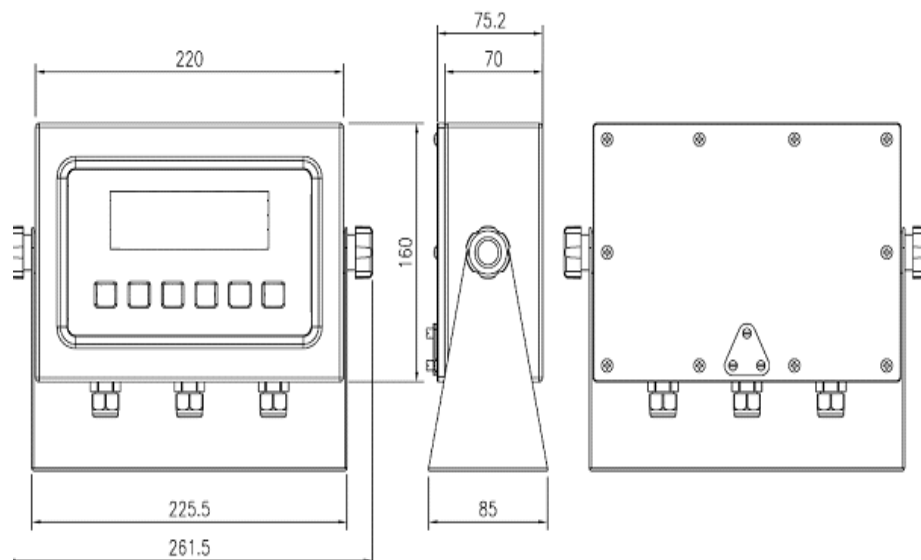

Figure 7.1 SBI-521 Outline Drawing

## 7.3 Power Supply

---

- 12 Vdc / min.500mA output AC adapter with central positive
- Optional 6V2.8AH lead-acid rechargeable battery
- Battery charging Circuit: built-in

Model	Working Current
SBI-521E	≤135mA (use adaptor, no load-cell, no battery, LED.BRT is set to 2)
SBI-521EB	≤100mA (use battery, no load-cell, no adaptor, LED.BRT is set to 2)
SBI-521C	≤80mA (use adaptor, no load-cell, no battery, backlight is on)
SBI-521CB	≤45mA (use battery, no load-cell, no adaptor, backlight is on)

## 7.4 Display

---

- SBI-521E: 7-digits,7-segment, 0.7"(17mm) ultra brightness LEDs with 16 annunciators
- SBI-521C: 6-digit,7-segment , 1"(25mm) LCDs with 16 annunciators and backlight

### 7.4.1 Keypad

---

- 6 push buttons

### 7.4.2 Environment

---

Working temperature	-10°C to 40°C
Storage temperature	-20°C to 70°C
Humidity	10 to 90% RH without condensation
Protection	IP65

### 7.4.3 Load Cell Excitation

---

Voltage	5Vdc
Max. Current	120mA (can power 8-350 ohm bridge)
Signal connection	4 or 6 lead with sense leads
Max Sensitivity	-3mV/V to +3mV/V

## 7.5 Communication

---

Serial port1	Full-duplex RS-232
Serial port2	Full-duplex RS-232 or half-duplex RS-485
Baud Rate	Selectable: 1200-2400-4800-9600-19200-22800/38400-57600 bps
Data Output Format	8N1, 7O1, 7E1
Protocol	programmable

## 7.6 Analog Circuitry

---

- 24-bit A/D converter
- Conversion Speed: 10Hz or 80Hz
- Input range: -15mV to +15mV
- Output code: 1mV input will output about 100,000 raw counts
- Hardware low pass filter and 2 programmable digital low pass filters

## 7.7 Capacity and Division

---

- Programmable
- Max display range: -999,999 to 999,999
- Division number range for primary unit: 100-100,000
- Division number range for second unit: 100-150,000
- Recommended Sensitivity: >0.5uV/ display division

## 7.8 Accuracy

---

≤0.01%

## 7.9 Calibration Method:

---

- Software calibration with long-term storage in EEPROM
- Provides smooth curve fit through four points
- Calibration can be done under kg or lb weight unit with 10% -100%FS standard weight.

## 7.10 Real Clock

---

- Built-in nonvolatile real time & date

## 7.11 Other Main Functions

---

- Programmable zero range
- Programmable pre-set tare weight
- Programmable automatic zero point tracking
- Programmable motion detection window
- Programmable auto-power off time, backlight working mode (LCD version) and adjustable LED brightness (LED Version)
- Programmable hold function with peak weight holding and dynamic weighing
- Available check weighing mode
- Available parts counting mode
- Available percentage working mode
- Available units of measure: kg, lb, lb:oz, PCS, %
- Data comparison and indicator of High, OK and Low is available in weigh mode, parts counting mode and percentage mode.
- Battery voltage display and charge indication
- Programmable serial output content

# 8 Troubleshooting

This chapter gives explanations on commonly seen errors, display characters and display symbols.

## 8.1 Display Characters

---

ASCII	LCD/LED	ASCII	LCD/LED	ASCII	LCD/LED
0		A		N	
1		B		O	
2		C		P	
3		D		Q	
4		E		R	
5		F		S	
6		G		T	
7		H		U	
8		I		V	
9		J		W	
		K		X	
		L		Y	
		M		Z	

## 8.2 Display Symbols

Symbol	Description
<i>U</i> -----	Zero is over the setting range
<i>0</i> -----	Zero point is below the setting range
<i>Ad</i> -----	Signal to ADC is over maximum range?
<i>Ad</i> -----	Signal to ADC is below minimum range
-----	Weight is over upper limitation or display data is over limitation
-----	Weight is below lower limitation
<i>EEPE1</i>	CONFIG or CAL parameters are not correctly set
<i>EEPE2</i>	USER parameter is not correctly set
<i>Lo.bAt</i>	Battery voltage is lower than setting.
<i>CAP</i> - - -	Next displaying content is capacity
<i>CAP.Er</i>	Parameters about Capacity is not correct
<i>CAL.P≡</i>	Calibration on point(x)
<i>CAL.OFF</i>	Calibration seal switch is on OFF position
<i>CAL.On</i>	Calibration seal switch is on ON position
<i>CAL.Er</i>	Calibration error, maybe input data or loaded weight is incorrect, unstable, non-linear
<i>CAL.End</i>	End calibration
<i>OFF</i>	Power OFF the indicator
<i>Stb.Er</i>	Unstable time is larger than setting of USER-OTHER-NLD.RNG
<i>AC</i> =====	Accumulation times is xxxx
<i>Pr.tArE</i>	Preset TARE weight
<i>CO≡P</i>	Input COMPARE data mode
<i>HIGH</i>	Input HIGH limitation data of Comparison
<i>LO≡</i>	Input LOW limitation data of Comparison
<i>SPL.Lo</i>	Sample load weight of low point.
<i>SPL.HI</i>	Sample load weight of high point.
<i>SPL.P≡t</i>	Sample goods weight to calculate piece weight
<i>InP.PCS</i>	Input number of pieces being counted
<i>Unit.kg</i>	Unit kg is selected
<i>Unit.lb</i>	Unit lb is selected
<i>P≡t.Er</i>	Piece weight error, sample too small (<0.5d).
<i>SPL.PCt</i>	Sample goods weight to calculate
<i>InP.PCt</i>	Input percentage of weighted goods
<i>PCt.Er</i>	Unit percentage weight is too small (<0.5d).



## 8.3 Troubleshooting

Symptom	Probable cause	Remedy
<i>Hd</i> ----- <i>Hd</i> -----	Load cell wires to indicator are incorrectly connected, shorted, opened, ADC or loadcell(s) are damaged.	Make sure wires are ok and correctly connected. Replace loadcell or ADC chip, Service required.
<i>0</i> -----	Weight reading exceeds Power On Zero limit.	Make sure scale platform is empty. Perform zero calibration.
<i>0</i> -----	Weight reading below Power On Zero limit.	Install platform on scale. Perform zero calibration.
-----	Weight reading exceeds Overload limit or the weight value cannot be displayed in the current unit of measure because it exceeds 6 digits.	Reduce load on scale until weight value can be displayed. Use a more appropriate unit of measure. Re-set some parameters of CONFIG or USER.
-----	Weight reading below Under load limit.	Install platform on scale. Perform zero calibration
<i>EEPE1</i>	CONFIG or CAL parameters are not correctly set	Re-set items in CONFIG, do calibration
<i>EEPE2</i>	USER parameter is not correctly set	Re-set items in USER
<i>CAPEr</i>	Capacity parameters are not correct	Set PRIM.N/PRIM.d/SECND.n to correct number, make sure capacity not more than 6 digit
<i>CALEr</i>	Calibration error. Input data or loaded weight is too small, too big, unstable, non-linear	Input correct data, load correct weight onto platform, Service required
<i>PEEr</i>	Piece weight is error, it's too small (<0.5d), The weight on the platform is too small to define a valid reference weight.	Use a greater weight for the sample.
<i>PLEEr</i>	Unit-Percentage -Weight is error, it's too small (the weight of 1%, 0.1%, or 0.01%-determined by CONFIG-FUNC-PERCNT is less than 0.5d)	Use more weight for the sample.
<i>SEbEr</i>	USER-HOLD-STB.TIM is too short, USER-HOLD-HLD.RNG is too small, other failure	Set USER-HOLD-STB.TIM longer, or set USER-HOLD-HLD.RNG bigger. Service required
Will not turn on.	Power cord not plugged in or properly connected. Power outlet not supplying electricity. Battery discharged. Other failure.	Check power cord connections. Make sure power cord is plugged into the power outlet. Check power source. Replace batteries. Service required.
Cannot zero the display or will not zero when turned on.	Load on scale exceeds allowable limits. Load on scale is not stable. Load cell damage.	Remove load on scale. Wait for load to become stable. Service required.
Cannot display weight in desired weighing unit.	Unit not set to enable or d≥5oz, when unit is lb:oz	Enable unit in CONFIG-UNITS
Battery symbol is empty or Lo.bAt is shown	Batteries are discharged.	Charge batteries



# Avery Weigh-Tronix



## **Avery Weigh-Tronix USA**

1000 Armstrong Dr.

Fairmont MN 56031 USA

Tel:507-238-4461

Fax:507-238-4195

Email: [usinfo@awtxglobal.com](mailto:usinfo@awtxglobal.com)

[www.wtxweb.com](http://www.wtxweb.com)

## **Avery Weigh-Tronix UK**

Foundry Lane,

Smethwick, West Midlands,

England B66 2LP

Tel:+44 (0) 8453 66 77 88

Fax: +44 (0)121 224 8183

Email: [info@awtxglobal.com](mailto:info@awtxglobal.com)

[www.averyweigh-tronix.com](http://www.averyweigh-tronix.com)