

PC3060

Price Computing Scale



User Instructions

Avery Weigh-Tronix is a trademark of the Illinois Tool Works group of companies whose ultimate parent company is Illinois Tool Works Inc (“Illinois Tool Works”). Copyright © 2019 Illinois Tool Works. All rights reserved.

No part of this publication may be reproduced by making a facsimile copy, by the making of a copy in three dimensions of a two-dimensional work and the making of a copy in two dimensions of a three-dimensional work, stored in any medium by electronic means, or transmitted in any form or by any means, including electronic, mechanical, broadcasting, recording or otherwise without the prior written consent of the copyright owner, under license, or as permitted by law.

This publication was correct at the time of going to print, however Avery Weigh-Tronix reserves the right to alter without notice the specification, design, price or conditions of supply of any product or service at any time.

Table of Contents

	<i>page</i>
Chapter 1 General information and warnings	5
About this manual	5
Text conventions	5
Special messages	5
Installation	6
Electrical installation	6
Pluggable equipment	6
Safe handling of equipment with batteries	7
Routine maintenance	7
Cleaning the machine	8
Training	8
Sharp objects	8
FCC and EMC declarations of compliance	8
Chapter 2 Specifications	9
Dimensions	10
Chapter 3 Introduction	12
Installation	12
Unpacking	12
Level Adjusting	12
Connect Adaptor	13
Parts description	14
Keyboard	14
Displays	15
Chapter 4 Operation	16
Initial startup	16
Power ON/OFF	16
Zero	16
Tare	16
Sample weighing	16
Unit price setting	17
Unit Price Memory	17
Back light	18
Automatic Unit Price Clear	19
Units of Measure	19
Accumulation function	19
Give Change	20
Commodities Without Weighing	20
Chapter 5 Parameter Settings	22
Getting into Parameter Menu	22
Enter Fxx Menu settings	22
Activating the Parameters	23
Parameter Menu Block	23
Chapter 6 Calibration	25
Chapter 7 Miscellaneous	26
RS232 output	26
Print Format	26
Error codes	27

Replacement parts	27
Sealing	28

1 General information and warnings

1.1 About this manual

This manual is divided into chapters by the chapter number and the large text at the top of a page. Subsections are labeled as shown by the 1 and 1.1 headings shown above. The names of the chapter and the next subsection level appear at the top of alternating pages of the manual to remind you of where you are in the manual. The manual name and page numbers appear at the bottom of the pages.

1.1.1 Text conventions

Key names are shown in **bold** and reflect the case of the key being described. This applies to hard keys and onscreen or soft keys.

Displayed messages appear in ***bold italic*** type and reflect the case of the displayed message.

1.1.2 Special messages

Examples of special messages you will see in this manual are defined below. The signal words have specific meanings to alert you to additional information or the relative level of hazard.



ELECTRICAL WARNING!
THIS IS AN ELECTRICAL WARNING SYMBOL.
ELECTRICAL WARNINGS MEAN THAT FAILURE TO FOLLOW SPECIFIC PRACTICES OR PROCEDURES MAY RESULT IN ELECTROCUTION, ARC BURNS, EXPLOSIONS OR OTHER HAZARDS THAT MAY CAUSE INJURY OR DEATH.



CAUTION!
This is a Caution symbol.
Cautions give information about procedures that, if not observed, could result in damage to equipment or corruption to and loss of data.



NOTE: *This is a Note symbol. Notes give additional and important information, hints and tips that help you to use your product.*

1.2 Installation



DANGER: RISK OF ELECTRICAL SHOCK. NO USER SERVICEABLE PARTS. REFER TO QUALIFIED SERVICE PERSONNEL FOR SERVICE.

DISCONNECT ALL POWER TO THIS UNIT BEFORE INSTALLING, CLEANING, OR SERVICING. FAILURE TO DO SO COULD RESULT IN BODILY HARM OR DAMAGE THE UNIT.

- The PC3060 price computing scale is a precision electronic instrument. Handle it carefully.
- Do not install the scale in direct sunlight.
- Verify the local voltage and receptacle type are correct for the scale.
- Only use the original adaptor as others could cause damage to the scale.
- Pluggable equipment must be installed near an easily accessible power socket outlet.
- Avoid unstable power sources. Do not use near large users of electricity such as welding equipment or large motors.
- Avoid sudden temperature changes, vibration, wind and water.
- Avoid heavy RF noise.
- Keep the scale clean.

1.3 Electrical installation



CAUTION: The power cable must be connected to an earth-grounded electrical outlet. The electrical supply must have a circuit breaker with an appropriate rating to protect from over-current conditions.

For your protection, all electrical (110V or 230V) equipment used out of doors or in wet or damp conditions should be supplied from a correctly fused power source and protected by an approved ground fault protection device (RCD, GFCI etc.)

IF IN DOUBT SEEK ADVICE FROM A QUALIFIED ELECTRICIAN.

1.3.1 Pluggable equipment

Pluggable equipment must be installed near an easily accessible socket outlet.

1.3.2 Safe handling of equipment with batteries



CAUTION: *Danger of explosion if battery is incorrectly replaced. Replace only with the same or equivalent type recommended by the manufacturer. Dispose of used batteries according to the manufacturer's instructions.*

ATTENTION: *Il y a danger d'explosion s'il y a remplacement incorrect de la batterie, remplacer uniquement avec une batterie du même type ou d'un type équivalent recommandé par le constructeur. Mettre au rebut les batteries usagées conformément aux instructions du fabricant.*



Safe Battery Disposal

Please be aware this product contains a lead acid battery which **MUST** be removed and disposed of safely prior to any disposal of the scale.

This battery can be easily accessed by removing the battery cover found on the underside of the scale.

1.4 Routine maintenance



IMPORTANT: *This equipment must be routinely checked for proper operation and calibration. Application and usage will determine the frequency of calibration required for safe operation.*

Always turn off the machine and isolate from the power supply before starting any routine maintenance to avoid the possibility of electric shock.

Make sure that it is placed securely on a flat and level surface.

1.5 Cleaning the machine

Table 1.1 Cleaning DOs and DON'Ts



DO	DO NOT
Wipe down the outside of standard products with a clean cloth, moistened with water and a small amount of mild detergent	Attempt to clean the inside of the machine
	Use harsh abrasives, solvents, scouring cleaners or alkaline cleaning solutions
Spray the cloth when using a proprietary cleaning fluid	Spray any liquid directly on to the display windows

1.6 Training

Do not attempt to operate or complete any procedure on a machine unless you have received the appropriate training or read the instruction books.

To avoid the risk of RSI (Repetitive Strain Injury), place the machine on a surface which is ergonomically satisfactory to the user. Take frequent breaks during prolonged usage.

1.7 Sharp objects

Do not use sharp objects such as screwdrivers or long fingernails to operate the keys.

1.8 FCC and EMC declarations of compliance

United States

This equipment has been tested and found to comply with the limits for a Class A digital device, pursuant to Part 15 of the FCC Rules. These limits are designed to provide reasonable protection against harmful interference when the equipment is operated in a commercial environment. This equipment generates, uses, and can radiate radio frequency energy and, if not installed and used in accordance with the instruction manual, may cause harmful interference to radio communications. Operation of this equipment in a residential area is likely to cause harmful interference in which case the user will be required to correct the interference at his own expense.

Canada

This digital apparatus does not exceed the Class A limits for radio noise emissions from digital apparatus set out in the Radio Interference Regulations of the Canadian Department of Communications.

Le présent appareil numérique n'émet pas de bruits radioélectriques dépassant les limites applicables aux appareils numériques de la Classe A prescrites dans le Règlement sur le brouillage radioélectrique édicté par le ministère des Communications du Canada.

2 Specifications

Display	15mm/0.59inch LCD Display with white LED back Light
Gross weight	4.1kg (9lb)
Capacity	15/30kg (30/60lb)
Readability	5/10g (0.01/02 lb)
Max. Divisions	2 x 3000e
Weighing Units	Kg/lb
Pan size	204 x 263mm/8.03 x 10.35inch
Housing	ABS Plastic and Stainless Steel pan
Interface	RS232 Output standard
Operation Temperature	-10°C -+ 40°C/14°F - 104°F
Stabilisation Time	1 Seconds typical
Power	AC Adaptor 12V/500mA, Rechargeable Battery 6V/3.2Ah
Keypad	20 keys
Zero range	0mV~5mV
Signal input range	0~15mV
ADC	Sigma delta
Internal counts	600,000
ADC update	Max 60 times/second
Load cell drive voltage	Max 5V/150mA

2.1 Dimensions

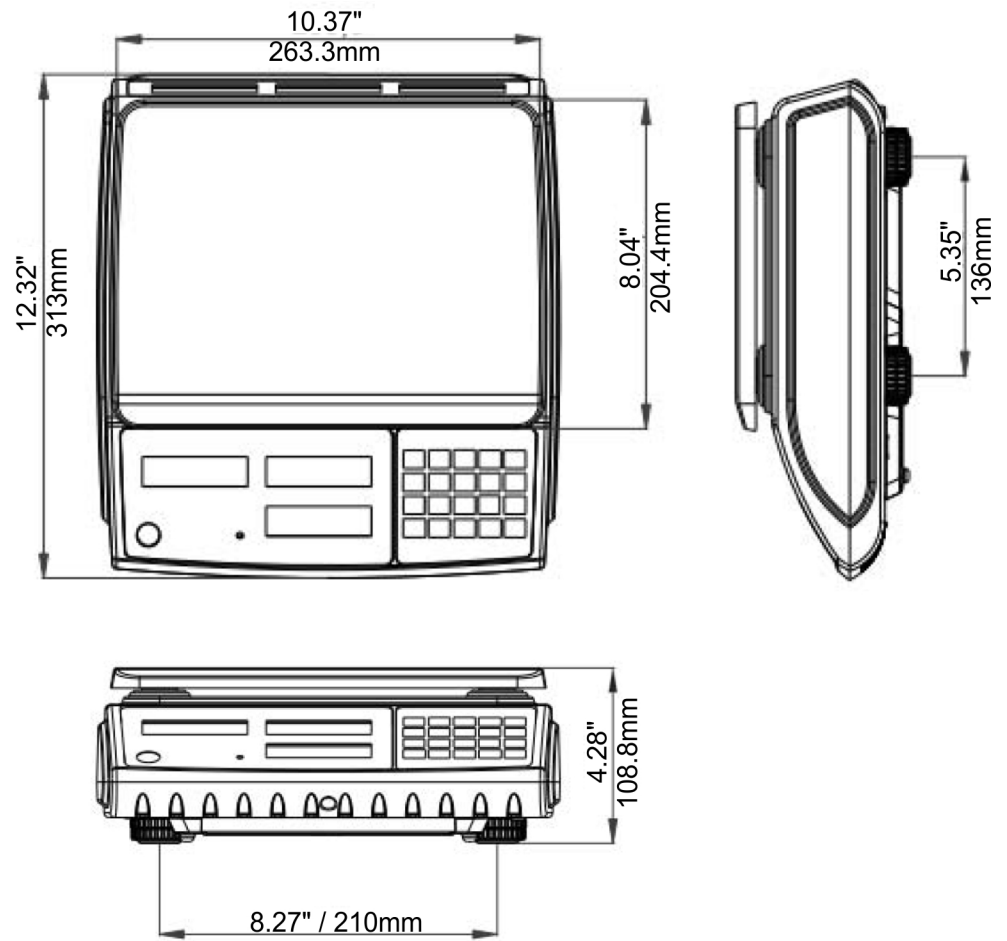

3 Introduction

The PC3060 price computing scales are accurate, compact, and very reliable.

- 3 easy-to-read backlit LCD displays; both front and rear make it ideal for use in low light conditions.
- 10 indirect PLUs, can store up to 10 unit price values for quick and easy recall
- Easy-to-use Accumulation and Change function
- Auto unit price clear operation
- Weighing units conversion(kg/lb)
- Standard RS-232 ideal for connecting to a printer or a cash register.

3.1 Installation

3.1.1 Unpacking

Carefully take the scale out of its package. Make sure it is not damaged, and all accessories are included.

Accessories:

- Scale
- Power adaptor
- Stainless steel pan
- User manual

3.1.2 Level Adjusting

Place the scale on a flat, level surface.

Check the level bubble to see if the scale is level. If the bubble is not in the center level ring, adjust the leveling feet until it is centered correctly.

3.1.3 Connect Adaptor

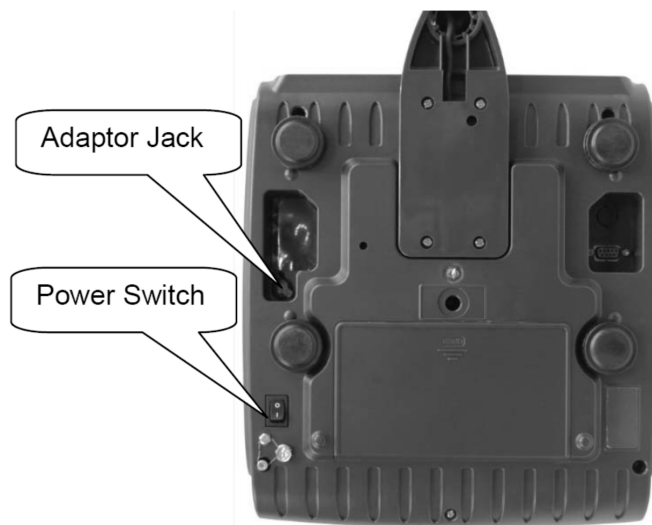

- To charge the battery, insert the adaptor pin into to jack socket on the underside of the scale. Plug the power adaptor into the mains power.
- The scale will charge even when the scale is turned off.
- The scale should be charged for at least 12 hours to fully recharge its battery.
- The CHARGE LED on the front of the scale will show the status of the battery. When the scale is plugged into the mains power, the internal battery will automatically start charging. If the LED is green, this means the battery has a full charge. If the LED is red, the battery is nearly discharged and will require charging. If the LED is yellow, the battery is being charged.
- Do not use any other type of power adaptor than the one supplied with the scale.
- Verify that the AC power socket outlet is properly protected.

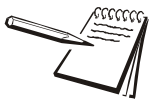





Charge the battery before using the scale for the first time.

3.2 Parts description

3.2.1 Keyboard



Keys	Press this key to
0 to 9	Numeric Keys, used to enter unit price/PLU. In setting mode, press numeric keys to enter parameters setting.
C	Clear incorrect entries and error conditions
□	In fixed mode, press to input double zero. In float mode, press to insert a decimal point.
→0← ZERO	Returns the display to zero. In parameter settings, used to escape from the menu.
↔T TARE	Subtracts the tare values, change from gross to net mode and to enter parameter settings.
SAVE	Enter to auto clear mode

Keys	Press this key to
	Used to store or recall unit price. In parameter setting mode, it is used to scroll down the menu.
	Used to give change operation.
	Add the current data to memory. In parameter setting mode, it is used to scroll up the menu.
	Used to change units of weight & unit price (kg/lb)
	Quantity key, use for entering in quantities without weighing.

3.2.2 Displays

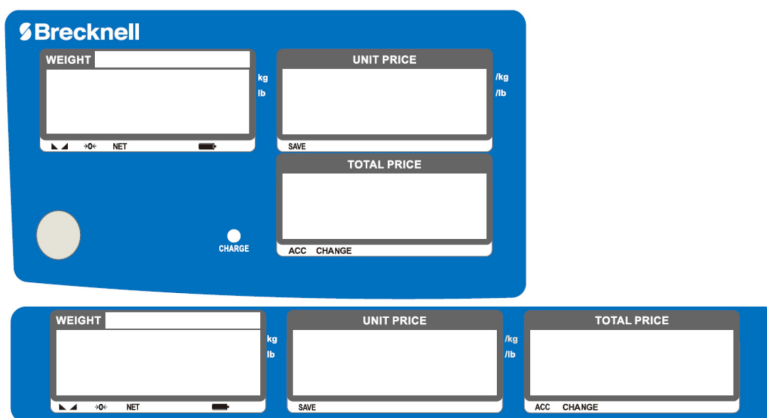

Display Symbols

BATT	Battery indicator. When illuminated, battery requires recharging. Plug in power adaptor to recharge.
NET	Net Weight
STABLE	Stable indicator. When illuminated, the scale is stable.
ZERO	Zero indicator. When illuminated, the scale is within the Zero window.
kg/lb	Current weighing unit
SAVE	Save Indicator
CHARGE	Battery charging indicator
ACC	Accumulation indicator
CH	Checkout indicator

4 Operation

4.1 Initial startup

To get the best performance from your PC3060, please allow a warm-up time of around 15 minutes to help stabilize the measured values after switching on.

4.1.1 Power ON/OFF

Power switch is located under the scale on the right-hand side. To switch on the scale, press and hold the on/off switch until the scale Beeps. The scale will turn on and the display will run through self-test screens before showing zero.

To switch off scale press the on/off switch again.

4.1.2 Zero

If the weight display does not return to zero with no weight on the scale, the display can easily be re-zeroed by pressing the **ZERO** key.

4.1.3 Tare

When weighing produce on a tray, film or, container, the weight of any container can easily be tared off, so you only see the Net weight of the produce being weighed.

1. Place the empty container to be tared off on the weighing pan and press the **TARE** key.

The display will tare off this weight and show a Net Zero weight on the display with the *NET* annunciator illuminated.

2. To clear a tare weight, remove all weight from the weighing pan and press the **TARE** key again. The display will return to Gross Zero and the *NET* annunciator will turn off.

4.1.4 Sample weighing

1. Place goods to be weighed on the weighing pan. Wait a few seconds for the display to stabilize.
2. Read the result.

To avoid overloading, when **o!** appears, reduce the load or unload the weight from the scale.

4.1.5 Unit price setting

Manual entry of unit price

The unit price will be based off the unit of measure the scale is set up to work within. This is calculated based off one of the following:

- Price per lb
- Price per kg

This is easily identified by the right-hand annunciator in the weight display area.

1. Make sure platform is empty and the display is showing zero.

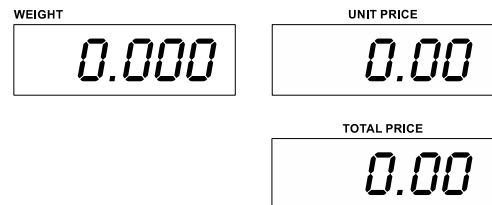

2. Place goods to be weighed on the weighing pan. (e.g. 1.5 lb)

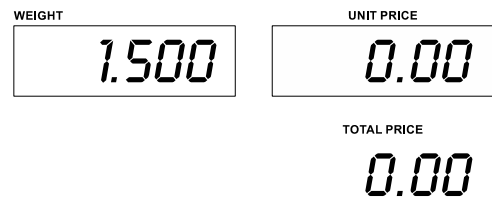

3. Enter in the unit price by pressing numeric keys. In this example \$5.00 is shown. Key in 500 or 5 followed by a decimal.

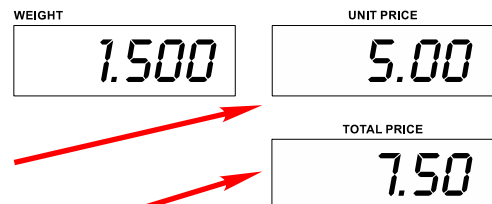

This will now be displayed in the *UNIT PRICE* display. Total price will be calculated automatically and shown on the *TOTAL PRICE* display.

4.1.6 Unit Price Memory

The PC3060 can store up to 10 unit price values. Price values can easily be selected using the 0 to 9 numeric keys.

Saving a Unit Price to PLU memory

1. Make sure you are in the correct unit of measure before starting.
2. Use the numeric keys and enter in the unit price per the selected unit of measure. (\$1.12 per lb in this example)

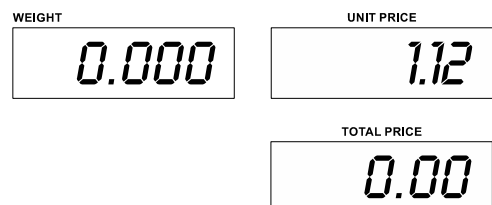

- Press and hold the **PLU** key. The display at right is shown.

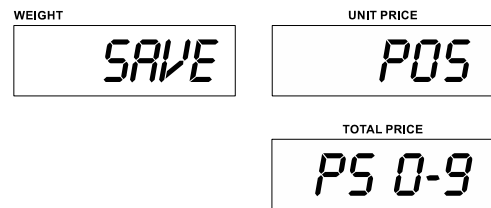

- Press a numeric key (0 to 9) to select the PLU stored location. If you want to select PLU 1, press numeric key 1.

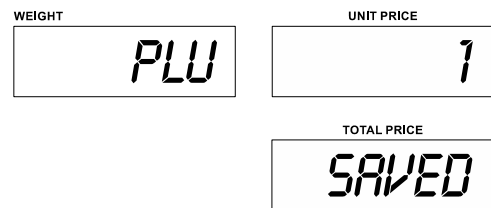

PLU key 1 is now saved with \$1.12 per lb

Recalling a stored PLU Unit Price

- To recall a stored PLU unit price, press the **PLU** key. The display at right is shown:

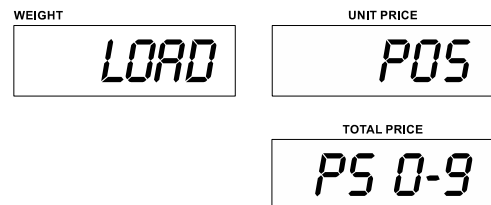

Key in the desired stored PLU number (0 to 9).

- To recall PLU 1, press 1.

Display will now load the stored unit price per the selected unit of measure.

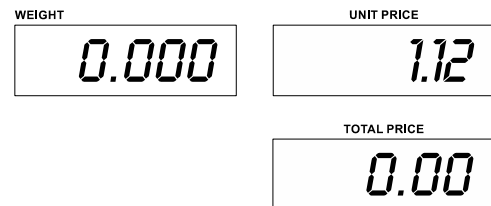

- Place the item to be weighed on the weighing pan and the PC3060 will automatically calculate the total price based on the recalled PLU unit price. See example at right.

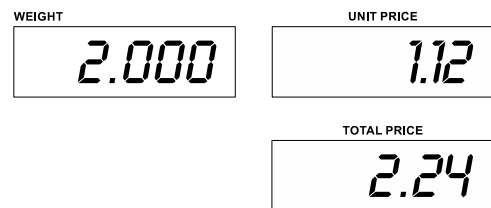

4.1.7 Back light

The PC3060 has the option to change the back light setting to help save battery life. Choices are AUTO – ON –OFF. Factory default is AUTO.

- In normal weighing mode, press and hold the decimal key, , until the display at right appears.

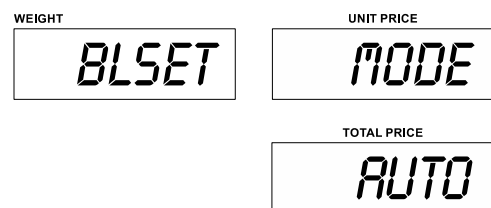

- Press the **M+** key to scroll through the backlight settings, AUTO – ON –OFF.

Display	Description
<i>BLSET MODE AUTO</i>	Backlight will be turned on, only at startup or when a change in weight is seen on the scale. Back light will go off after 5 seconds once the weight becomes stable or at zero.
<i>BLSET MODE ON</i>	Backlight will be always on
<i>BLSET MODE OFF</i>	Backlight function will be always off

4.1.8 Automatic Unit Price Clear

The PC3060 scale can be set to automatically clear the unit prices once the scale returns to zero weight.

To activate the Automatic Unit Clear function, press and hold the SAVE key while turning off the scale.

Now when a unit price is entered and used, once the weight display returns to Zero, the unit price will automatically be cleared.

To turn off this feature, repeat this process.

4.1.9 Units of Measure

Subject to the markets the PC3060 is to be used in, the **UNITS** key may be deactivated so the unit of measure cannot be changed.

In the markets where lb and kg can legally be used, the **UNITS** key is active.

To change the unit of measure from lb to kg, make sure the scale is at zero. Press the **UNITS** key to change weighing unit from lb to kg. The *lb* annunciator will go out and the *kg* annunciator will illuminate.

4.1.10 Accumulation function

The scale can be set to accumulate manually by pressing the **M+** key.

To turn on the accumulation functions see the **F11 RS232>mode>t parameter on page 24.**



Before entering parameters, press the calibration switch. Switch is located below the scale and may only be accessed if the scale has not been sealed.

To use this feature, the scale needs to have a stable reading and be able to return to zero; only accumulated weight over 20 divisions can be accumulated.

The values (price) displayed may be added to the accumulated values by pressing the **M+** key. The **TOTAL PRICE** display will show the total price for two seconds before reverting to the next item.

The scale must return to zero or a negative value before another sample can be stored.

Other products may be added by pressing the **M+** key. It may take up to 99 entries or until it reaches the maximum displayable digits.

To view the total price stored, press the **M+** key when there is no weight on the scale. The total will be displayed for two seconds.

To clear the memory, press the **CLEAR** key, , to clear all values.

4.1.11 Give Change

After accumulating total price, you can use the **CHANGE** key to work out the exact change that needs to be given. (total being \$24.60 in the example shown below)

1. Press the **CHANGE** key, , and the *Change* annunciator in the *TOTAL PRICE* display will illuminate.

WEIGHT	24.60	UNIT PRICE	0
--------	-------	------------	---

The total cost will now be shown in the *WEIGHT* display.

TOTAL PRICE	-----
-------------	-------

2. Use the numeric keys to enter in the money handed over by the customer (\$30.00 in this example).

WEIGHT	24.60	UNIT PRICE	30.00
--------	-------	------------	-------

This will be shown in the *UNIT PRICE* display and the change will be shown in the total price display.

TOTAL PRICE	6.40
-------------	------

3. Press the **TARE** key to return the scale to normal weighing mode and clear the account memory.

4.1.12 Commodities Without Weighing

For products that are not weighed but are priced individually per item, these can easily be added by using the **QTY** key.

1. Use the numeric keys to enter the unit price of the item (\$1.56 each in the example at right) and then press the **QTY** key.

WEIGHT	0	UNIT PRICE	1.56
--------	---	------------	------

TOTAL PRICE	0.00
-------------	------

2. Enter the quantity (a quantity of 5). The *WEIGHT* display will show 5 and the *TOTAL PRICE* display will now show the total price (\$7.80).

WEIGHT	5	UNIT PRICE	1.56
--------	---	------------	------

TOTAL PRICE	7.80
-------------	------

3. Press the **QTY** key to return normal weighing mode

5 Parameter Settings

5.1 Getting into Parameter Menu

1. Turn on the scale. Press and hold the **TARE** key during the self-test.
Pn is shown briefly, asking you to enter a PIN number. The default PIN number is **0000**.
2. Press the **0** four times to enter the PIN number to get into the parameter menu.
. The display will show **Pn - - - -**.
3. Press the **TARE** key to confirm. The scale will now give you access to the parameter settings of the PC3060 and the display will show **menu unit kg or lb**.

5.1.1 Enter Fxx Menu settings

Press the **TARE** key to enter the parameter listed on the display.

Press the **M+** key to move up or the **PLU** key to move down the parameter menu list.

Press the **TARE** key to enter the parameter.

Press the **ZERO** key to escape from the menu and exit back to weighing mode.

5.1.2 Activating the Parameters



To access or change any parameter, the CAL switch located on bottom of the scale may have to be pressed.

Press the CAL switch to enable parameters.

5.1.3 Parameter Menu Block

Menu	Sub-Menu	Description
F0 CAL		Calibration
F1 rES	3000	Set external resolution
	6000	
	Dual-i	
	Dual-r	
F2 CAP	3KG/6lb	Set Scale Capacity
	6KG/12lb	
	15KG/30lb	
	30kg/60lb	
F3 PdECi	0	Set Price Decimal Point
	0	
	0.0	
	0.00	
	0.000	
	0.0000	
F4 PdESC	FIX	Set unit Price to FIXED or FLOATING
	FLOAT	
F5 SPEED	Slow	To select A/D speed
	Medium	
	Fast	
F6 Min coin	1/2/5/10	Select minimum coin
F7 SCSIU tare	ON	Multi - Tare function ON
	OFF	Multi - Tare function OFF
F8 ISN		This display will show XXXXX for indicating the internal counts.
F9 Gra		To set your local gravity value.
F10 Reset		Factory default settings

Menu	Sub-Menu	Description	
F11 rS232	ModE	prin	The scale RS232 protocol will be determined by the Baud & Pr
		tr	settings
		tpup	Enable accumulation function, and press M+ key to send data to printer
		Lp50	Enable accumulation function, and press M+ key to send data to printer
		POS	Protocol Type: POS
		oFF	RS232 function disable
		Cont	Continuous data transmission
		StC	Stable data sending continues
		toledo	Protocol Type 1: Toledo
		nciecr	Protocol Type 2: NCI-ECR
		ncigen	Protocol Type 3: NCI-General
		tec	Protocol Type 4: TEC
		easy	Protocol Type 5: Easy Weigh
	baud	Set baud rate to (1200/2400/4800/9600/19200/38400/115200)	
	Pr	8n1	8 data bits, no verify, 1 stop bit
		7E1	7 data bits, Even verify, 1 stop bit
7o1		7 data bits, Odd verify, 1 stop bit	



Press the **UNITS** key to choose kg or lb unit in the setting mode, capacity will be shown in kg or lb values.

6 Calibration

1. Turn on the scale and press and hold the **TARE** key during the self-test.
Display will show "Pn".
2. Key in the PIN number to get into the scales parameter menu. The default PIN number is 0000.
3. Press the **0** numeric key four times...
Pn - - - - is displayed.
4. Press the **TARE** key to enter the parameter settings.
menu unit kg is displayed.
 - a. If calibrating in kg, continue to step 5.
 - b. If calibrating in lb, press the **UNITS** key until **lb** is shown on the display.
5. Press the **TARE** key to confirm...
f0 cal is displayed.



Press calibration switch to enable these settings and allow calibration to be completed.

The calibration switch below the scale may be sealed if legally trade stamped. It is recommended that recalibration is only carried out by a qualified technician.

6. Remove all weight from weighing pan and make sure **STABLE** indication is visible on the display.
7. Press the **TARE** key to confirm...
unload is displayed.
8. Press the **TARE** key to confirm...
CAP loadXX is displayed.
9. If necessary, press the **M+** key to select the calibration weight value and then place the calibration weight on the weighing pan.
10. When the weight becomes stable, press the **TARE** key to confirm...
PASS is briefly displayed and then **F0 Cal**.
11. Calibration is now complete.
12. Remove calibration weight from the platform.
13. Press the **ZERO** key to go back to the weighing mode.

7 Miscellaneous

7.1 RS232 output

The PC3060 Series of scales can be connected to a standard printer using the RS-232 output found under the scale.

7.1.1 Print Format

*****	*****
Total	NET 10.000
\$ 300.00	Unit Price
Pay	\$ 30.00 /lb
\$ 310.00	Price
Change	\$ 300.00
\$ 10.00	Total
*****	\$ 300.00
*****	*****
NET 10.000	*****
Unit Price	Total
\$ 30.00 /kg	\$ 300.00
Price	Pay
\$ 300.00	\$ 310.00
Total	Change
\$ 300.00	\$ 10.00
*****	*****

7.2 Error codes

Error Message	Description	Solution
----	Maximum load exceeded	Unload or reduce weight
Err 1	Incorrect date	Enter the date by using format "yy:mm:dd"
Err 2	Incorrect time	Enter the time by using format "hh:mm:ss"
Err 4	Zero setting error	Zero setting range exceeded due to switching on. (4%max) Make sure platform is empty.
Err 5	Key board error	Check the keys and connector.
Err 6	A/D value out of range	Make sure platform empty and check the pan is installed proper. Check the load cell connectors.
Err 7	Percentage error	Value should be (0.01% weight must > 0.5d)
Err 9	Unstable Reading	Check any air variation, vibration, RF noise and touching somewhere. Check the load cell and connectors.
Err 10	Communication error	No data (RS-232, continuous communication)
Err 15	Enter gravity error	Gravity range (0.9~1.0)
Err 17	Tare out of range	Remove the load and restart scale again.
Err19	Initial zero error	Calibrate the scale.
--ol--	Over range	Remove the load. Recalibrate
Fai l h/ fail	Calibration Error	Recalibrate
Err p	Printer error	Check the printer and settings
Ba lo/ lo ba	Battery low	Recharge battery, check the voltages.

7.3 Replacement parts

Part number	Description
AWT25-502479	Power supply USA (input 100-240V 50/60Hz 0.25A output 12V 0.5A)
AWT25-502480	Power supply UK (input 100-240V 50/60Hz 0.25A output 12V 0.5A)
	Replacement battery
AWT20-509299	Replacement feet Kit (4 feet and lock nuts)
AWT20-509300	Replacement top pan

7.4 Sealing

All sealing to be carried out in line with NTEP CC #18-119, or EC approval cert: 0200-NAWI-05154,



A wire seal is passed through the holes in two sealing screws mounted on the bottom of the scale.

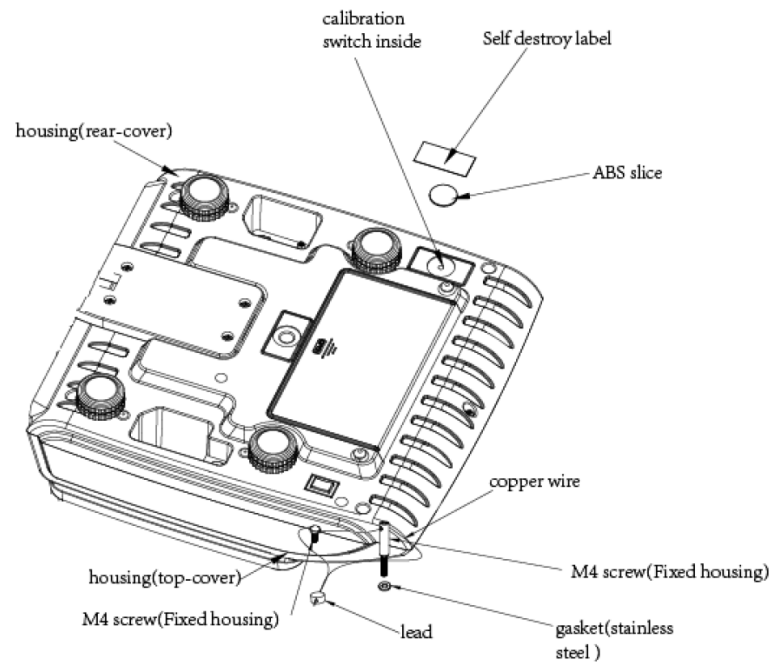

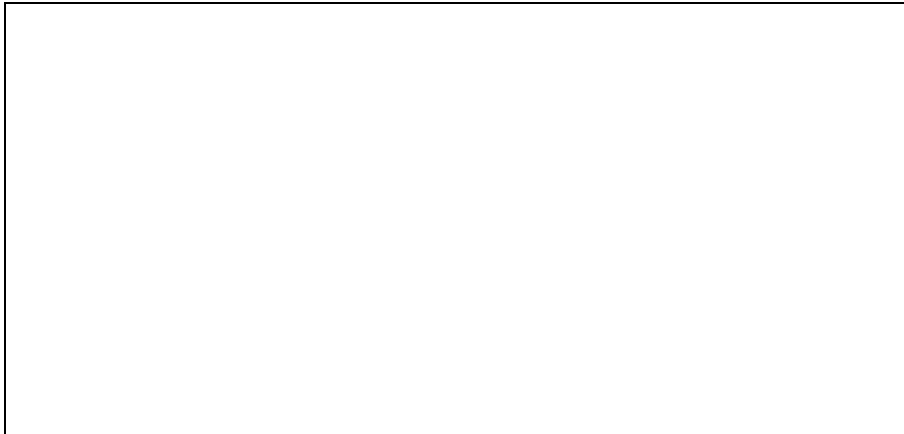

Brecknell USA

1000 Armstrong Dr.
Fairmont MN 56031
Toll free:800-637-0529
Tel:507-238-8702
Fax:507-238-8271
Email:sales@brecknellscales.com
<http://brecknellscales.com>

Brecknell UK

Foundry lane,
Smethwick, West Midlands
England, B66 2LP
Tel:+ 44 (0) 8452 466717
Fax:+44 (0) 8452 466718
Email:sales@brecknellscales.co.uk
<http://brecknellscales.com>